



**CATALOGO GENERALE**  
**GENERAL CATALOGUE**



# CATALOGO GENERALE

GENERAL CATALOGUE

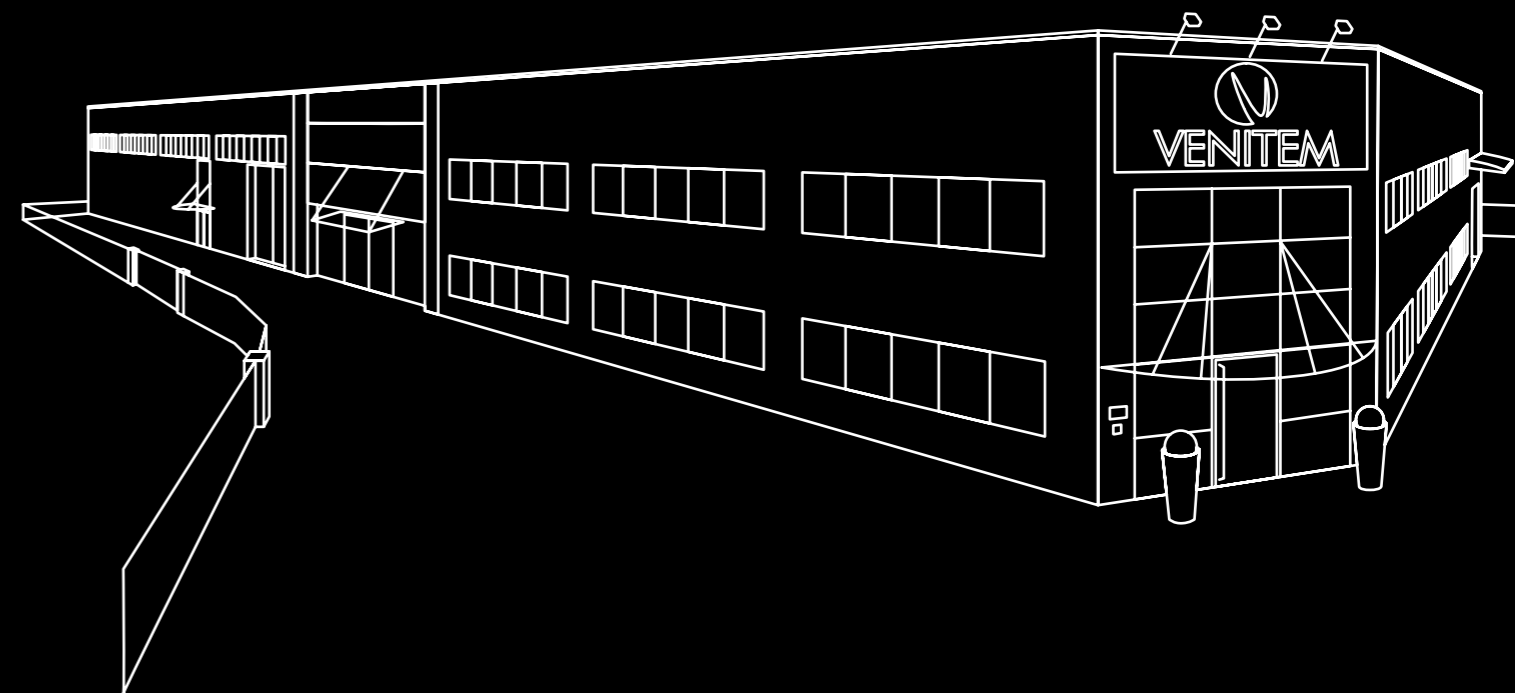

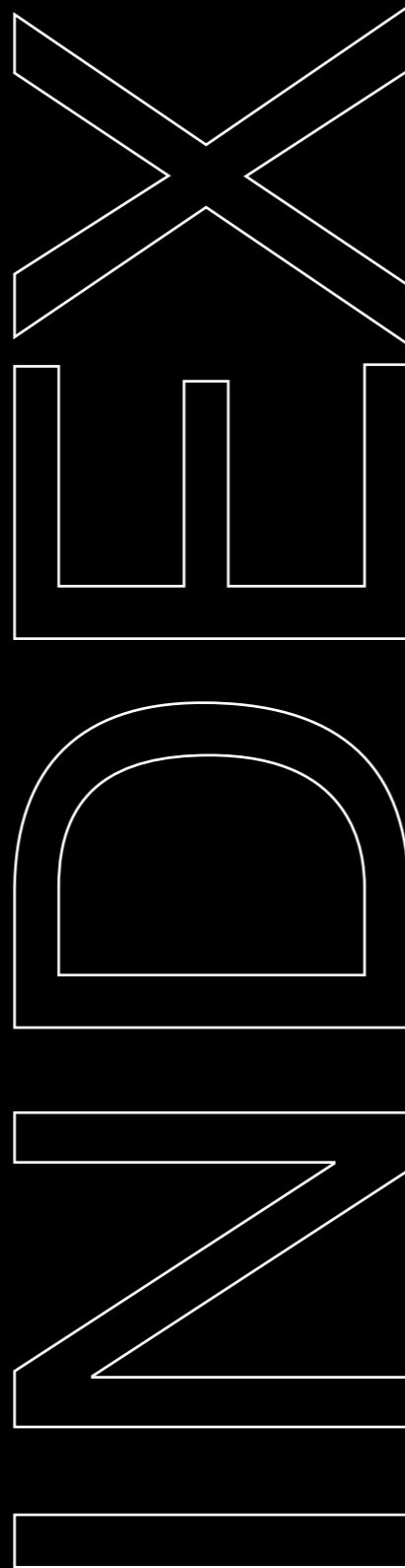

INTRO	4
SIRENE D'ALLARME ALARM SOUNDERS	13
Sirene antifurto da esterno Intrusion outdoor alarm sounders	20
Sirene antifurto da interno Intrusion indoor alarm sounders	76
Sirene antincendio e evacuazione Fire alarm and evacuation sounders	99
CENTRALI D'ALLARME ALARM CONTROL PANELS	109
ALIMENTATORI: TECNOLOGIA MULTIFUNZIONE POWER SUPPLIES: MULTI-FUNCTION TECHNOLOGY	121
SCHEDE RELÈ E MULTIFUNZIONE RELAY AND MULTI-FUNCTION BOARDS	141
ALTRI PRODOTTI OTHER PRODUCTS	147
Contatti magnetici Magnetic contacts	148
Pannelli e sirene per uscite di emergenza Panels and sounders for emergency exit	152
Segnalatori ottico-acustici Optical-acoustic signalers	154
Tastiere wireless Wireless keypad	158
Radiocomandi e ricevitori Vela Vela remote control and receivers	160
LA NOSTRA STRUTTURA OUR STRUCTURE	168



MIGLIOR DESIGN,  
LA TECNOLOGIA PIÙ AVANZATA,  
PER UNA SICUREZZA INFALLIBILE

THE BEST DESIGN, THE MOST  
ADVANCED TECHNOLOGY FOR  
A FLAWLESS SECURITY

Venitem è protagonista nella produzione di sistemi per la sicurezza civile ed industriale. Prodotti di estrema raffinatezza, risultato del genio italiano, che uniscono alla tradizione, una tecnologia avanzata ed un design unico.

Prodotti per sistemi antifurto e antincendio, sempre attuali e certificati secondo le più recenti normative. Sirene d'allarme filari o wireless, alimentatori per i più svariati tipi di impianto, schede relè, pannelli ottico-acustici, radiocomandi e molti altri prodotti, estremamente intuitivi, semplici da installare e da utilizzare. Prodotti unici, eleganti e alla portata di tutti, per un sistema d'allarme sicuro, efficace e "stiloso".

Venitem is one of the best Italian manufacturers of civil and industrial security systems. Smart products, result of Italian genius, gathering tradition, advanced technology and unique design.

Products for burglar and fire alarm systems, always original and certified according to the most recent standards. Wired and wireless alarm sounders, power supplies for any kind of security systems, relay boards, optical-acoustic panels, radio-transmitters and many other products, easy to install and to use. Unique, elegant and competitive products for a safe, efficient and "stylish" security system.



VENITEM

## MADE IN ITALY

Gusto, ma non solo. Tecnologia e qualità riconosciute in tutto il mondo. Design originale, soluzioni curate nel dettaglio, tecniche produttive quasi artigianali per meticolosità ed eccellenza. Venitem mantiene ancora oggi una produzione 100% Made in Italy: ciascun prodotto viene trattato come se fosse un pezzo unico e realizzato con componenti di provenienza italiana. I test computerizzati eseguiti su ciascun pezzo sono tesi ad assicurare al mercato prodotti infallibili ed estremamente performanti. La tradizione Made in Italy e l'innovazione si uniscono nei prodotti Venitem, per una sicurezza che stupisce.

Fine taste, but not only. Venitem technology and high quality are recognized all over the world. Original design, care for details, production techniques recalling to artisans excellence and meticulousness. Venitem is today one of the rare realities offering a 100% Made in Italy production: any item is treated as a masterpiece, according to tradition, it is realized using high-quality components and it is carefully tested in order to assure the market perfect performances. Made in Italy tradition and innovation are gathered at Venitem for an astonishing security.

## AZIENDA CERTIFICATA CERTIFIED COMPANY

Venitem è azienda certificata ISO 9001 e ISO 14001, che assicura alti standard qualitativi ed un sistema aziendale organizzato secondo i criteri di efficienza e nel rispetto dell'ambiente.

Venitem is ISO 9001 and ISO 14001 certified, assuring its customers top-level products, an organized system and an environmentally-friendly manufacturing process.



## PRODOTTI CERTIFICATI CERTIFIED PRODUCTS

I prodotti Venitem sono certificati e realizzati nel rispetto delle più recenti normative Nazionali ed Europee.

Venitem products are certified and manufactured according to the main Italian and European standards.



**Conformi alla Norma Europea EN 50131**  
**Complying with EN 50131 European Standard**

# DESIGN

Un design che lascia il segno ed apre una nuova tendenza nella storia dei prodotti per la sicurezza. Linee apprezzate a livello internazionale, realizzate da menti brillanti e creative. Un'evoluzione della specie che inizia dalle classiche sirene in metallo e continua con innovativi case in ABS, estremamente performanti, malleabili e adatti ad ogni tipo di personalizzazione. L'utilizzo di materiali innovativi, colorazioni e finiture speciali realizzate con tecniche avanzatissime, permette di accontentare le più svariate richieste della clientela.

A design leaving its signature and giving life to a new trend in the history of security products. Aesthetic solutions appreciated at international level, realized by creative and brilliant minds. The evolution of the species begins with classical metal sounders and continues with cutting-edge ABS housings, extremely performing and suitable for any kind of customization. The use of innovative materials, special colours and finishing, realized with advanced techniques, is able to satisfy the most various market requirements.

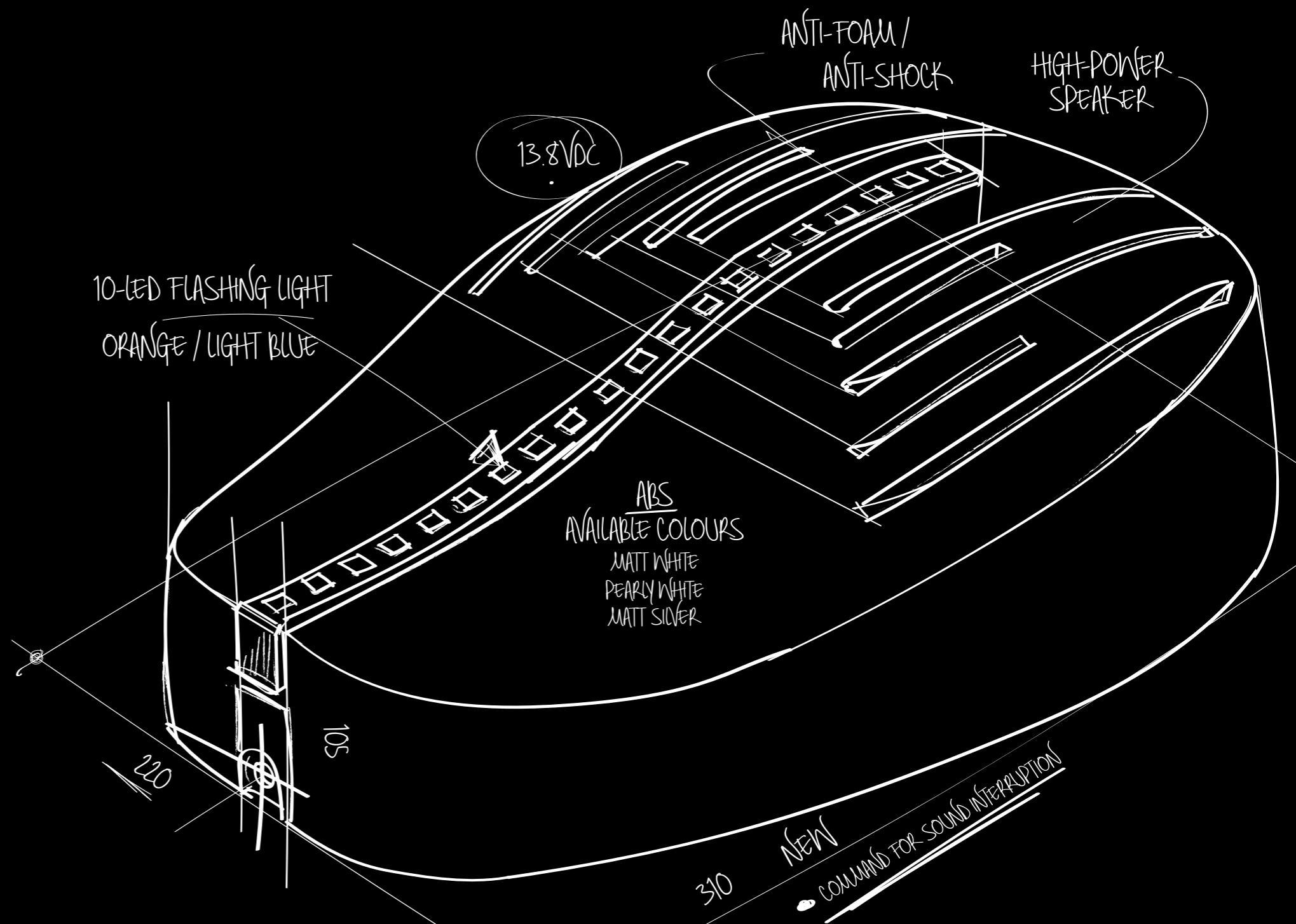

# PRODOTTI

## PRODUCTS

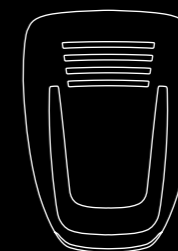

SIRENE D'ALLARME  
ANTIFURTO E ANTINCENDIO  
DA ESTERNO E DA INTERNO

OUTDOOR AND INDOOR  
INTRUSION AND FIRE ALARM  
SOUNDSES

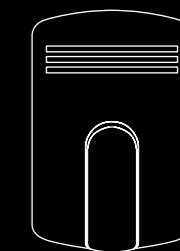

SIRENA / CENTRALE  
"ALL IN ONE"

"ALL IN ONE"  
SOUNDER / CONTROL PANEL

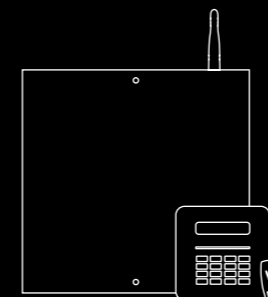

CENTRALI D'ALLARME PER  
SISTEMI ANTIFURTO E TVCC

CONTROL PANELS FOR  
CCTV AND INTRUSION  
SYSTEMS

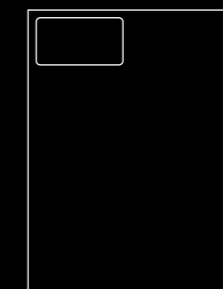

ALIMENTATORI DA ESTERNO  
E INTERNO

INDOOR AND OUTDOOR  
POWER SUPPLIES

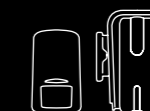

SENSORI DA ESTERNO E  
INTERNO

DETECTORS FOR OUTDOOR  
AND INDOOR USE



RADIOCOMANDI E TASTIERE  
ROLLING CODE

ROLLING CODE REMOTE  
CONTROLS AND WIRELESS  
KEYPADS



SEGNALATORI OTTICI E  
ACUSTICI

OPTICAL AND ACUSTIC  
SIGNALERS

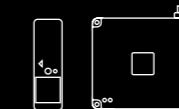

CONTATTI MAGNETICI

MAGNETIC CONTACTS



SCHEDA RELÈ E SCHEDA  
MULTIFUNZIONE

RELAY AND MULTI-FUNCTION  
BOARDS



SIRENE E PANNELLI PER  
USCITA DI EMERGENZA

SOUNDERS AND PANELS  
FOR EMERGENCY EXIT

## SOLUZIONI SU MISURA

### CUSTOMIZED SOLUTIONS

Venitem offre soluzioni personalizzate, consentendo a ciascun cliente di realizzare prodotti "su misura" da utilizzare come vero e proprio biglietto da visita. Grazie alle numerose possibilità di customizzazione e alla vasta gamma cromatica disponibile, Venitem garantisce la soddisfazione delle più svariate esigenze estetiche.

Venitem offers its customers a number of highly personalized solutions, granting a "tailored" product perfectly representing the customer's style. The wide range of customized solutions and the great choice available allow Venitem to satisfy the most diverse aesthetic needs.

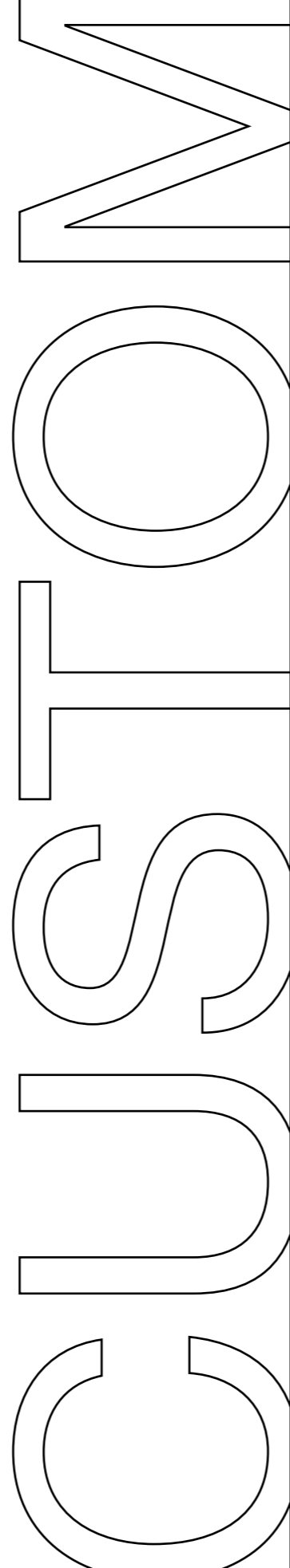



SIRENE D'ALLARME  
ALARM SOUNDERS



# HIGH TECHNO LOGY

Le sirene Venitem presentano una tecnologia innovativa, risultato di un'approfondita ricerca tecnica capace di creare soluzioni adatte ad ogni tipo di esigenza.

Venitem sounders offer an advanced technology resulting from a thorough technical research able to create solutions suitable for every need.

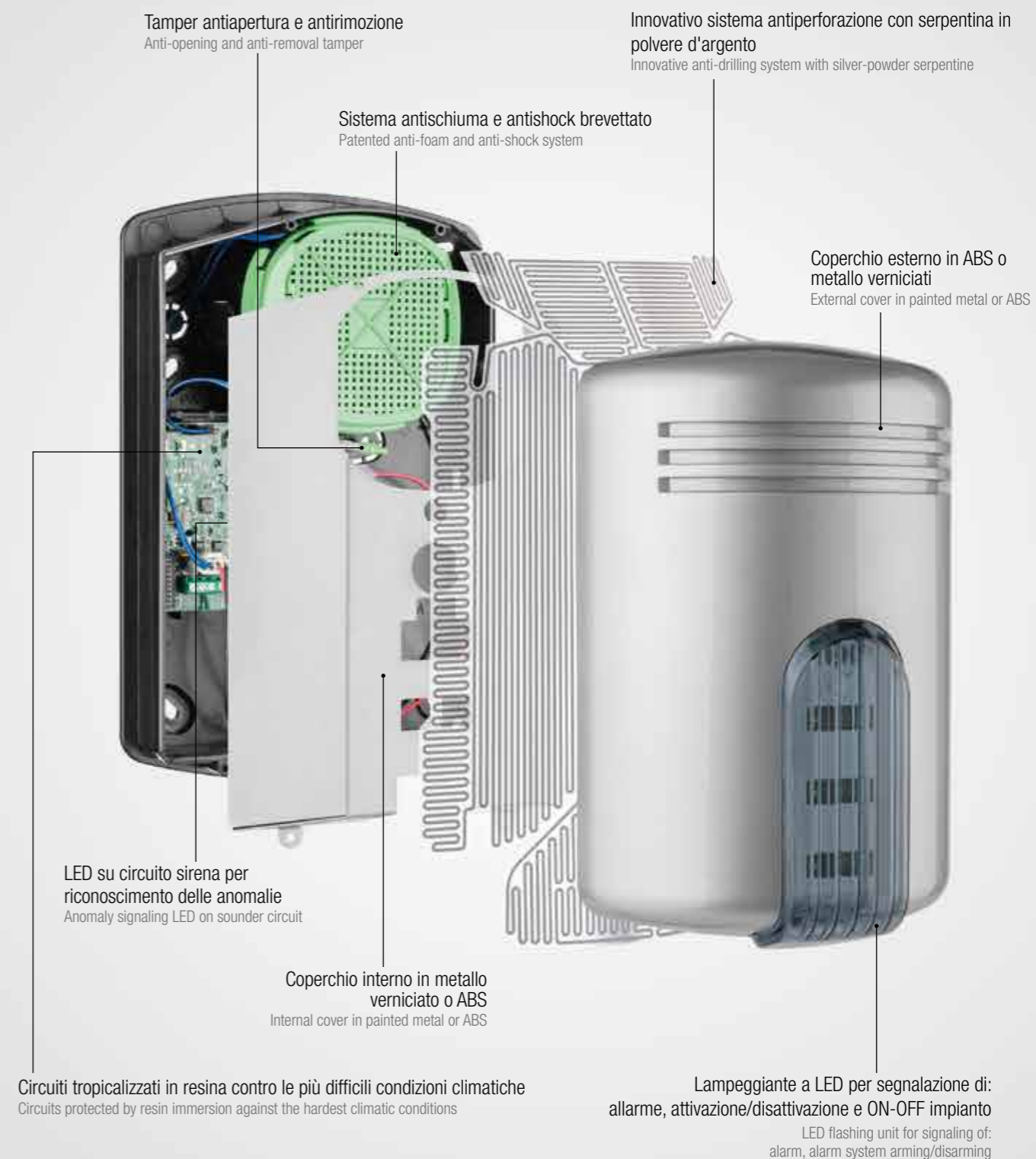

## COLORAZIONI INNOVATIVE INNOVATIVE COLOURS

Le sirene Venitem vengono verniciate utilizzando uno speciale e innovativo processo che assicura un'ottima durata del colore nel tempo ed una straordinaria resistenza ai fattori atmosferici. L'ampia gamma cromatica regala soluzioni estremamente originali, che comprendono colorazioni perlate, metallizzate, opache e "spazzolate".

Il processo di cromatura viene realizzato tramite un particolare processo di galvanizzazione ad immersione, per assicurare un'ottima resa e una durata garantita del colore. Novità assoluta le nuove colorazioni "Tech", realizzate a mano, per conferire al prodotto un carattere unico.

Venitem sounders are painted using a special and innovative process that grants a long-lasting brilliant colour able to face the most adverse weather conditions. The wide offer of colours ranges over pearly colours, metal effects as well as amazing brush effects.

The chrome-plating process is realized through galvanic immersion granting excellent duration. Moreover, the new hand-made "Tech" colours give our products a unique character.

## NUOVE COLORAZIONI "TECH" NEW "TECH" COLOURS

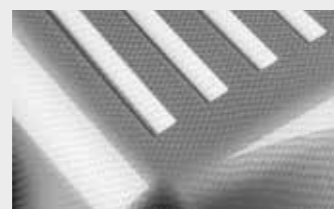

Grigio lucido "TECH"  
"TECH" Shiny Grey

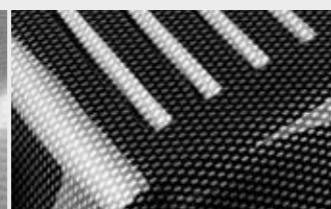

Nero lucido "TECH"  
"TECH" Shiny Black

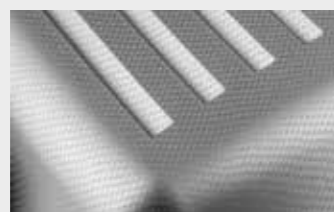

Grigio opaco "TECH"  
"TECH" Matt Grey

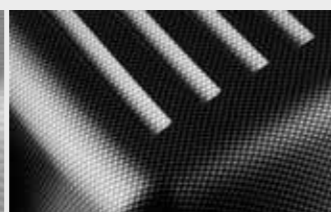

Nero opaco "TECH"  
"TECH" Matt Black

## ADESIVI / SERIGRAFIE STICKERS / SERIGRAPHIES

Soluzioni sempre accattivanti adatte a tutti i tipi di personalizzazione, dalla più semplice alla più originale.

Pleasant solutions suitable for any kind of personalization, for an always original and creative result.

## DECALCO DECAL

Un tipo di personalizzazione innovativa ed elegante, mai utilizzata prima nel settore, estremamente resistente e adatta a chi vuole valorizzare il suo prodotto e renderlo raffinato.

A new and long-lasting technique for an added value, to obtain an extremely smart product.



# SIRENE D'ALLARME

## ALARM SOUNDERS

### ANTIFURTO INTRUSION

ESTERNO / OUTDOOR

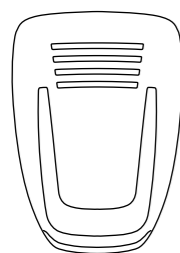

MOSE



MURANO

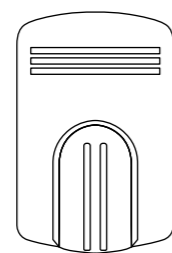

DUCALE

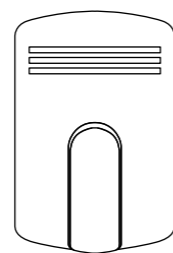

DOGE  
DOGE WIRELESS

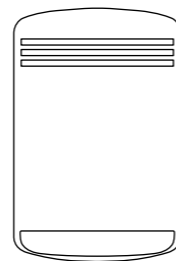

HOLA

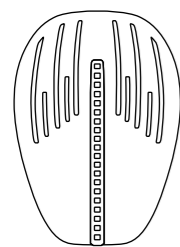

RIO

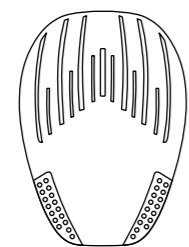

RONDÒ

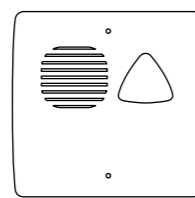

TRIADE

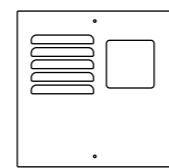

RIALTO

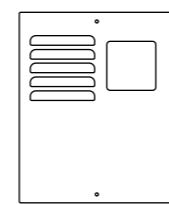

LIDO

by **SYLCO**  
the sound of security  
by Venitem Group

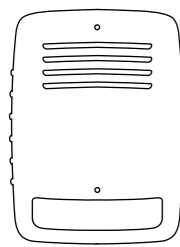

ECO 800

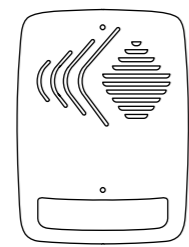

ECO 700

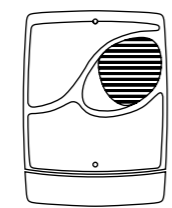

ECO 600

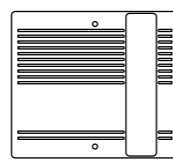

ECO 560

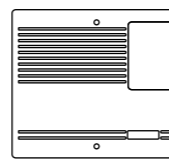

ECO 500

### ANTIFURTO INTRUSION

INTERNO / INDOOR



MINI HOLA



MINI MURANO



MINI DOGE

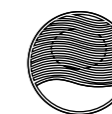

SP 200



GHOST

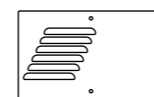

LAGUNA



SP 303T



SP 203T

### ANTINCENDIO FIRE

ESTERNO / OUTDOOR

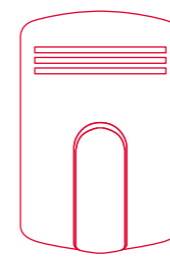

DOGE F24

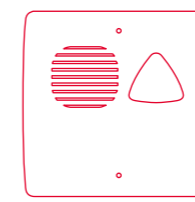

TRIADE F24

INTERNO / INDOOR



MINI DOGE F24  
MINI DOGE FL24

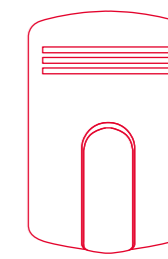

DOGE EV

### EVACUAZIONE EVACUATION

# SIRENE ANTIFURTO DA ESTERNO

## INTRUSION OUTDOOR ALARM SOUNDER

	MOSE	MURANO	DUCALE	DOGE	DOGE <sup>WIRELESS</sup>	HOLA	RIO	RONDÒ	TRIADE	RIALTO	LIDO	ECO 800	ECO 700	ECO 600	ECO 560	ECO 500
Sistema di illuminazione a LED brevettato Patented LED lighting system	•															
Scheda vocale digitale Digital vocal module	•		•													
Tamper antiapertura e antirimozione Anti-opening and anti-removal tamper	TR	TR	TM	TM	TR	TM	TM	TM	TR	TR	TR	TM	TM	TM	TM	TM
Sistema antischiuma / antishock Anti-foam / anti-shock system	•	•	•	•	•	•	•	•	•	•	•	•	•	•	•	•
Protezione antiperforazione Anti-drilling protection	•	•	•	•	•	•										
Tromba Speaker	▲	▲	▲	▲	•	•	▲	•	•	•	•	•	•	•	•	•
ON/OFF positivo e negativo settabili da dip switch Positive and negative ON/OFF settable by dip switch	•	•	•	•		•	•	•	•	•	•	•	•	•	•	•
Conteggio allarmi Alarm counting	•	•	•	•		•	•	•	•	•	•				•	•
Comando di interruzione suono Speaker block	•	•	•	•		•	•		•	•	•	•	•		•	•
Numero suoni Sounds number	4	4	4	4	4	4	2	2	2	2	2	2	2	2	2	2
Numero temporizzazioni Timings number	4	4	4	4	4	4	2	2	2	2	2	2	2	2	2	2
Lampeggiante comandabile separatamente Possibility to manage flashing light separately	•	•	•	•		•						•	•	•	•	•
Controllo batteria secondo normativa EN 50131-4 Battery control according to EN 50131-4 standard	•	•	•	•		•	•	•	•	•	•	•	•	•	•	•
Uscita guasti / anomalie Failures / anomalies output	•	•	•	•		•	•		•	•	•	•	•	•	•	•
Circuiti tropicalizzati in resina Circuits tropicalized by resin immersion	•	•	•	•	•	•	•	•	•	•	•	•	•	•	•	•
Bolla di centratura Spirit level	•	•	•	•	•	•	•	•	•	•	•					
Coperchio esterno External cover	P	P	P	P	P	P	P	P	P	M/X	M/X	M/X	M/X	P	P	P/X

• = NOVITÀ / NEW

▲ = Tromba ad alta potenza / High-power speaker

TR = Reed magnetico / Magnetic reed

TM = micro switch contatti dorati / micro switch with gold-plated contact

P = plastica ABS anti UV / Anti-UV ABS plastic

M = metallo verniciato / painted metal

X = acciaio INOX / Stainless steel

# MOSE

Innovazione e alte prestazioni per Mose, la sirena d'allarme multifunzione che unisce design e alta tecnologia. Il nuovo sistema brevettato di illuminazione a LED ad alta luminosità trasforma la sirena in un'elegante lampada da esterno e la scheda vocale digitale la rende la migliore sirena parlante del mercato.

Innovation and high performance for Mose, the multi-function intrusion sounder joining the most vanguard technology to smart design and materials. The patented high-luminosity LED lighting system turns this siren in an elegant outdoor lamp and the digital vocal module makes it the best speaking sounder in the market.

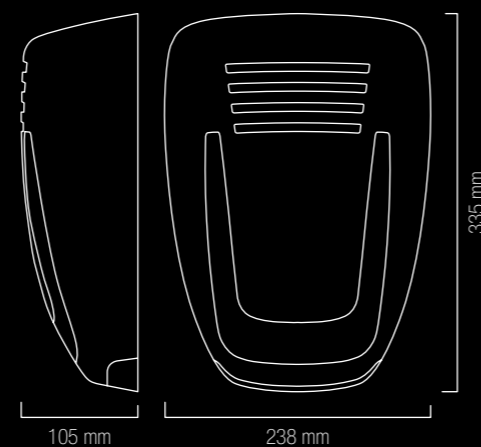

Sistema antischiuma e antishock brevettato  
Patented anti-foam and anti-shock system

Sistema vocale con scheda audio digitale  
Vocal system with digital audio module

Messaggi vocali personalizzabili  
Customizable vocal messages

Innovativo sistema antiperforazione  
Innovative anti-drilling system

Sistema di illuminazione a LED brevettato con funzione di lampada da esterno  
Patented LED lighting system with external lamp function

## DI SERIE STANDARD FEATURES

ON/OFF positivo e negativo settabile da dip switch  
Positive and negative ON/OFF settable by dip switch

Comando di interruzione suono  
Command for sound interruption

Controllo batteria secondo normativa EN 50131  
Battery control according to EN 50131 standard

Segnalazione ottica e acustica impianto ON/OFF  
Optical and acoustic ON/OFF signaling

4 Suoni programmabili e 4 temporizzazioni settabili da dip switch  
4 programmable sounds and 4 timings settable by dip switch

Bolla di centratura / Spirit level





# MURANO

La sirena d'allarme che rompe gli schemi del design unendo estetica e cura del dettaglio alla più sofisticata tecnologia. Un prodotto innovativo, una garanzia di protezione.

The alarm sounder that breaks the traditional design schemes joining aesthetic and care for details and the most vanguard technology. An innovative product that guarantees a total protection.

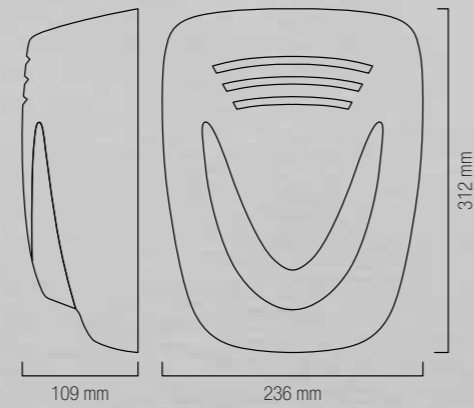

Sistema antischiuma e antishock brevettato  
Patented anti-foam and anti-shock system

Innovativo sistema antiperforazione  
Innovative anti-drilling system

Lampeggiante a LED  
comandabile separatamente  
Separately controllable  
LED flashing unit

Design raffinato  
Elegant design

security&safety  
award 2008

TOP SELECTION  
DESIGN

## DI SERIE STANDARD FEATURES

ON/OFF positivo e negativo settabile da dip switch  
Positive and negative ON/OFF settable by dip switch

Comando di interruzione suono  
Command for sound interruption

Controllo batteria secondo normativa EN 50131  
Battery control according to EN 50131 standard

Segnalazione ottica e acustica impianto ON/OFF  
Optical and acoustic ON/OFF signaling

4 Suoni programmabili e 4 temporizzazioni settabili da dip switch  
4 programmable sounds and 4 timings settable by dip switch

Bolla di centratura / Spirit level



## COLORI COLOURS

Coperchio Esterno  
External cover

- Rosso perlato / Pearly red
- Verde perlato / Pearly green
- Grigio argentato / Silver grey
- Bianco perlato / Pearly white
- Cromo / Chromium  
Colore disponibile con supplemento  
Colour available at extra cost

Calotte  
Flash covers

- Arancio / Orange
- Fumè / Smoke grey

## PERSONALIZZAZIONI CUSTOMIZATIONS

Supplemento per colore cromo  
Extra cost for chromium version

Supplemento per colorazioni personalizzate  
(min. 100 pz.)  
Extra cost for customized colours (100 pcs. min.)

Finiture speciali - colori "TECH"  
Special finishings - "TECH" colours

Adesivi (min. 200 pz.) Serigrafie (min. 50 pz.)  
Decalco (min. 50 pz.)  
Embossed stickers (200 pcs. min.) Serigraphies (50 pcs. min.)  
Decal (50 pcs. min.)

## RICAMBI ACCESSORY

Coperchio esterno in ABS verniciato  
External cover in painted ABS

Calotta per lampeggiante in policarbonato  
Colori disponibili: arancio e fumè  
Polycarbonate cover for flashing device  
Available colours: orange and smoke grey



	MURANO L	MURANO LS	MURANO LSP	CIVETTA / DUMMY
Alimentazione / Power supply: <b>13.8 Vdc</b>	•	•	•	
Assorbimento MAX dalla centrale MAX consumption from alarm control panel: <b>800 mA</b>	•	•	•	
Assorbimento a riposo / Standby consumption: <b>15 mA</b>	•	•	•	
Assorbimento in allarme dalla batteria Battery consumption in alarm: <b>1.4 A</b>	•	•	•	
Assorbimento LED / LED consumption: <b>100 mA</b>	•	•	•	
Frequenza fondamentale / Fundamental frequency: <b>1432 Hz</b>	•	•	•	
Potenza sonora MAX a 1 m / Sound level MAX at 1 m: <b>dB</b>	<b>114</b>	<b>114</b>	<b>114</b>	
Memoria allarme / Alarm memory	•	•	•	
Possibilità di comando a 3 o 2 fili 3 or 2 wires control option	•	•	•	
Limite allarmi giornalieri / allarmi infiniti (settabili da dip switch) MAX daily / infinite alarms (settable by dip switch)	•	•	•	
Test sirena e batteria comandabile da remoto Remote control of sounder and battery test	•	•	•	
Uscita anomalia / Anomaly output	•	•	•	
LED interno per individuazione anomalia (su circuito sirena) Anomaly signaling LED (on sounder board)	•	•	•	
Sistema antiapertura e antirimozione a doppio tamper Anti-opening and anti-removal double-tamper system	•	•	•	
Sistema antischiuma e antishock brevettato a doppia rilevazione Patented double-detection anti-foam and anti-shock device		•	•	
Sistema antiperforazione / Anti-drilling system			•	
Grado di sicurezza / Security level	<b>3</b>	<b>3</b>	<b>4</b>	
Classe ambientale / Environmental class: <b>IV</b>	•	•	•	
Grado protezione / Protection level: <b>IP 44</b>	•	•	•	
Temperatura di funzionamento / Operating temperature: <b>-25°C ÷ +55°C</b>	•	•	•	
Resistenza all'impatto / Impact resistance: <b>IK 08</b>	•	•	•	
Batteria / Battery: <b>12 V 2.1 Ah Pb o/or 12 V 1.2 Ah Pb</b>	•	•	•	
Certificazione di Conformità alla Normativa <b>EN 50131-4</b> Complying with <b>EN 50131-4</b> Standard	•	•	•	
 Marchio / Marks: <b>IMQ Sistemi di sicurezza</b>	•	•	•	
 Marchio / Marks: <b>INCERT</b>	•	•	•	
Peso (gr.) / Weight (gr.)	<b>2147</b>	<b>2146</b>	<b>2180</b>	<b>894.5</b>
Pezzi a confezione / Pieces per pack	<b>5</b>	<b>5</b>	<b>5</b>	<b>5</b>



# DUCALE

Ducale è una sirena elegante e raffinata, che eredita il rinomato design Doge e lo valorizza con nuove funzionalità; un sofisticato microprocessore capace di soddisfare qualsiasi esigenza prestazionale, si unisce ad una nuova calotta lampeggiante, che viene arricchita con guide luce per aumentare la comunicazione visiva a LED. L'innovativa versione vocale, con scheda audio digitale, permette un'immediata discriminazione del tipo di intrusione e un intervento deterrente estremamente efficace.

Ducale is one of the smartest Venitem sounders, inheriting Doge design with additional valuable functions: a sophisticated microprocessor capable to meet any performance requests in addition to a new flash cover enriched by special guides aimed at increasing the LED visual communication. The new vocale version with digital audio module allows an immediate discrimination of the type of intrusion, thus offering an extremely useful deterring action.

## DI SERIE STANDARD FEATURES

ON/OFF positivo e negativo settabile da dip switch  
Positive and negative ON/OFF settable by dip switch

Comando di interruzione suono  
Command for sound interruption

Controllo batteria secondo normativa EN 50131  
Battery control according to EN 50131 standard

Segnalazione ottica e acustica impianto ON/OFF  
Optical and acoustic ON/OFF signaling

4 Suoni programmabili e 4 temporizzazioni settabili da dip switch  
4 programmable sounds and 4 timings settable by dip switch

Bolla di centratura / Spirit level

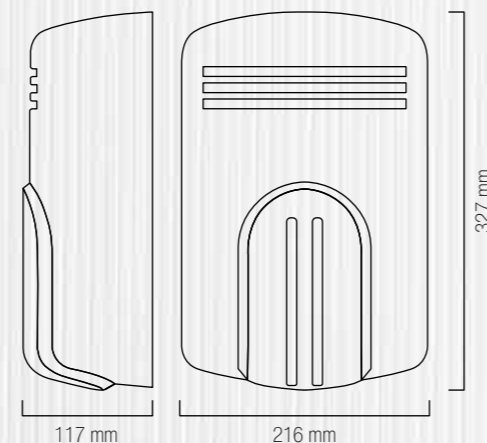

Sistema antischiuma e antishock brevettato  
Patented anti-foam and anti-shock system

Innovativo sistema antiperforazione  
Innovative anti-drilling system

Lampeggiante a LED comandabile separatamente  
Separately controllable LED flashing unit

Guide luce per ottimizzare la comunicazione visiva a LED  
Light guides to optimize LED optical communication





## COLORI COLOURS

Coperchio Esterno  
External cover

- Bianco opaco / Matt white
- Grigio opaco / Matt grey
- Bianco perlato / Pearly white
- Cromo / Chromium  
Colore disponibile con supplemento  
Colour available at extra cost

Calotte  
Flash covers

- Arancio / Orange
- Azzurro / Light blue
- Fumè / Smoke grey

## PERSONALIZZAZIONI CUSTOMIZATIONS



Supplemento per colore cromo  
Extra cost for chromium version

Supplemento per colorazioni personalizzate  
(min. 100 pz.)  
Extra cost for customized colours (100 pcs. min.)

Finiture speciali - colori "TECH"  
Special finishings - "TECH" colours

Adesivi (min. 200 pz.) Decalco (min. 50 pz.)  
Embossed stickers (200 pcs. min.) Decal (50 pcs. min.)



	DUCALE L	DUCALE LS	DUCALE LSP	CIVETTA / DUMMY
Alimentazione / Power supply: <b>13.8 Vdc</b>	•	•	•	
Assorbimento MAX dalla centrale MAX consumption from alarm control panel: <b>800 mA</b>	•	•	•	
Assorbimento a riposo / Standby consumption: <b>15 mA</b>	•	•	•	
Assorbimento in allarme dalla batteria Battery consumption in alarm: <b>1.4 A</b>	•	•	•	
Assorbimento LED / LED consumption: <b>100 mA</b>	•	•	•	
Frequenza fondamentale / Fundamental frequency: <b>1432 Hz</b>	•	•	•	
Potenza sonora MAX a 1 m / Sound level MAX at 1 m: <b>dB</b>	<b>114</b>	<b>112.6</b>	<b>112.6</b>	
Memoria allarme / Alarm memory	•	•	•	
Possibilità di comando a 3 o 2 fili 3 or 2 wires control option	•	•	•	
Limite allarmi giornalieri / allarmi infiniti (settabili da dip switch) MAX daily / infinite alarms (settable by dip switch)	•	•	•	
Test sirena e batteria comandabile da remoto Remote control of sounder and battery test	•	•	•	
Uscita anomalia / Anomaly output	•	•	•	
LED interno per individuazione anomalia (su circuito sirena) Anomaly signaling LED (on sounder board)	•	•	•	
Sistema antiapertura e antirimozione a doppio tamper Anti-opening and anti-removal double-tamper system	•	•	•	
Sistema antischiama e antishock brevettato a doppia rilevazione Patented double-detection anti-foam and anti-shock device		•	•	
Sistema antiperforazione / Anti-drilling system			•	
Grado di sicurezza / Security level	<b>3</b>	<b>3</b>	<b>4</b>	
Classe ambientale / Environmental class: <b>IV</b>	•	•	•	
Grado protezione / Protection level: <b>IP 44</b>	•	•	•	
Temperatura di funzionamento / Operating temperature: <b>-25°C ÷ +55°C</b>	•	•	•	
Resistenza all'impatto / Impact resistance: <b>IK 08</b>	•	•	•	
Batteria / Battery: <b>12 V 2.1 Ah Pb o/or 12 V 1.2 Ah Pb</b>	•	•	•	
Certificazione di Conformità alla Normativa <b>EN 50131-4</b> Complying with <b>EN 50131-4</b> Standard	•	•	•	
 Marchio / Marks: <b>IMQ Sistemi di sicurezza</b>	•	•	•	
 Marchio / Marks: <b>INCERT</b>	•	•	•	
Peso (gr.) / Weight (gr.)	<b>2337</b>	<b>2310</b>	<b>2399</b>	<b>1149</b>
Pezzi a confezione / Pieces per pack	<b>6</b>	<b>6</b>	<b>6</b>	<b>6</b>

# DOGE

Design elegante e raffinato. Una vasta gamma cromatica per una sirena d'allarme di alta tecnologia capace di assicurare una totale protezione conferendo stile e carattere a tutti i tipi di ambiente.

An elegant design, a wide chromatic range for an high-technology alarm sounder able to assure a total protection giving style and character to all kinds of installation locations.

## DI SERIE STANDARD FEATURES



ON/OFF positivo e negativo settabile da dip switch  
Positive and negative ON/OFF settable by dip switch

Comando di interruzione suono  
Command for sound interruption

Controllo batteria secondo normativa EN 50131  
Battery control according to EN 50131 standard

Segnalazione ottica e acustica impianto ON/OFF  
Optical and acoustic ON/OFF signaling

4 Suoni programmabili e 4 temporizzazioni settabili da dip switch  
4 programmable sounds and 4 timings settable by dip switch

Bolla di centratura / Spirit level

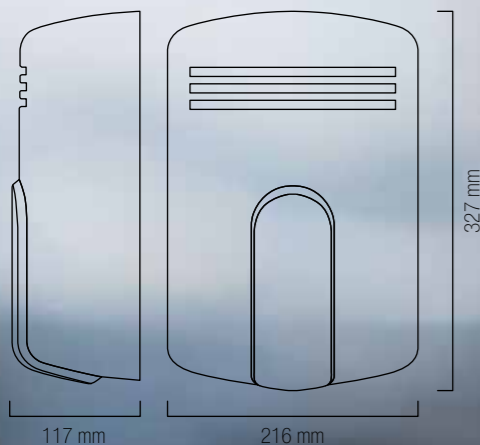

Sistema antischiuma e antishock brevettato  
Patented anti-foam and anti-shock system

Innovativo sistema antiperforazione  
Innovative anti-drilling system

Lampeggiante a LED comandabile separatamente  
Separately controllable LED flashing unit

Vasta gamma cromatica ottenuta tramite uno speciale processo di verniciatura in grado di garantire un'ottima tenuta del colore nel tempo  
Wide chromatic range obtained through a special painting process able to guarantee that colours last in time

## COLORI COLOURS

### Coperchio Esterno External cover

- Avorio / Ivory
- Acciaio / Grey
- Champagne / Champagne
- Celeste / Light blue
- Rame / Copper
- Bronzo / Bronze
- Rosso / Red
- Cromo / Chromium  
Colore disponibile con supplemento  
Colour available at extra cost

### Calotte Flash covers

- Arancio / Orange
- Fumè / Smoke grey

## PERSONALIZZAZIONI CUSTOMIZATIONS

Supplemento per colore cromo  
Extra cost for chromium version

Supplemento per colorazioni personalizzate  
(min. 100 pz.)  
Extra cost for customized colours (100 pcs. min.)

Finiture speciali - colori "TECH"  
Special finishings - "TECH" colours



Adesivi (min. 200 pz.) Decalco (min. 50 pz.)  
Embossed stickers (200 pcs. min.) Decal (50 pcs. min.)

## RICAMBI ACCESSORY

Coperchio esterno in ABS verniciato  
External cover in painted ABS

Calotta per lampeggiante in policarbonato  
Colori disponibili: arancio e fumè  
Polycarbonate cover for flashing device  
Available colours: orange and smoke grey



	DOGE L	DOGE LS	DOGE LSP	CIVETTA / DUMMY
Alimentazione / Power supply: <b>13.8 Vdc</b>	•	•	•	
Assorbimento MAX dalla centrale MAX consumption from alarm control panel: <b>800 mA</b>	•	•	•	
Assorbimento a riposo / Standby consumption: <b>15 mA</b>	•	•	•	
Assorbimento in allarme dalla batteria Battery consumption in alarm: <b>1.4 A</b>	•	•	•	
Assorbimento LED / LED consumption: <b>100 mA</b>	•	•	•	
Frequenza fondamentale / Fundamental frequency: <b>1432 Hz</b>	•	•	•	
Potenza sonora MAX a 1 m / Sound level MAX at 1 m: <b>dB</b>	<b>114</b>	<b>112.6</b>	<b>112.6</b>	
Memoria allarme / Alarm memory	•	•	•	
Possibilità di comando a 3 o 2 fili 3 or 2 wires control option	•	•	•	
Limite allarmi giornalieri / allarmi infiniti (settabili da dip switch) MAX daily / infinite alarms (settable by dip switch)	•	•	•	
Test sirena e batteria comandabile da remoto Remote control of sounder and battery test	•	•	•	
Uscita anomalia / Anomaly output	•	•	•	
LED interno per individuazione anomalia (su circuito sirena) Anomaly signaling LED (on sounder board)	•	•	•	
Sistema antiapertura e antirimozione a doppio tamper Anti-opening and anti-removal double-tamper system	•	•	•	
Sistema antischiama e antishock brevettato a doppia rilevazione Patented double-detection anti-foam and anti-shock device		•	•	
Sistema antiperforazione / Anti-drilling system			•	
Grado di sicurezza / Security level	<b>3</b>	<b>3</b>	<b>4</b>	
Classe ambientale / Environmental class: <b>IV</b>	•	•	•	
Grado protezione / Protection level: <b>IP 44</b>	•	•	•	
Temperatura di funzionamento / Operating temperature: <b>-25°C ÷ +55°C</b>	•	•	•	
Resistenza all'impatto / Impact resistance: <b>IK 08</b>	•	•	•	
Batteria / Battery: <b>12 V 2.1 Ah Pb o/or 12 V 1.2 Ah Pb</b>	•	•	•	
Certificazione di Conformità alla Normativa <b>EN 50131-4</b> Complying with <b>EN 50131-4</b> Standard	•	•	•	
 Marchio / Marks: <b>IMQ Sistemi di sicurezza</b>	•	•	•	
 Marchio / Marks: <b>INCERT</b>	•	•	•	
Peso (gr.) / Weight (gr.)	<b>2255</b>	<b>2229</b>	<b>2317</b>	<b>1060</b>
Pezzi a confezione / Pieces per pack	<b>6</b>	<b>6</b>	<b>6</b>	<b>6</b>

# DOGE WIRELESS

Compatibile con qualsiasi tipo di centrale, Doge wireless offre soluzioni di protezione complete anche nei sistemi più complessi evitando di intervenire con opere invasive. Doge wireless funziona in abbinamento con i dispositivi bi-direzionali ATX2/S e ATX3 capaci di comandare fino a 8 sirene wireless.

Compatible with any kind of control panel, the original design of Doge is transferred to its wireless version. Venitem is able to offer a complete security solution to adapt to the most complex systems without carrying out invasive works.

Doge wireless function comes in combination with two-way devices ATX2/S and ATX3 (able to control up to 8 wireless sounders).

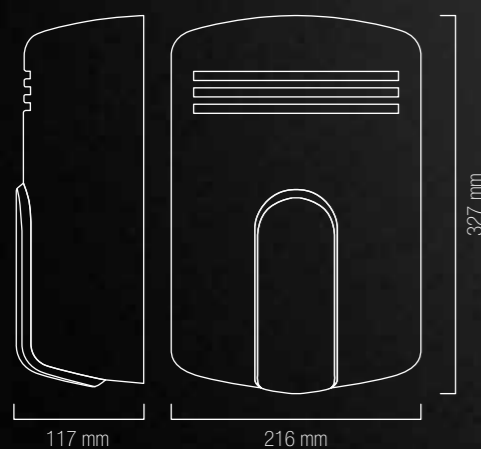

## DATI TECNICI TECHNICAL DATA

Alimentazione (pacchetto batterie alcaline size "D") Power supply (alkaline battery pack size "D")	7.5 V
Assorbimento a riposo / Standby consumption	100 microA
Frequenza di trasmissione / Receiving frequency	433.92 MHz
Frequenza di ricezione / Optical signaling	433.92 MHz
Potenza sonora a 1 m / Sound level at 1 m	108 dB (A)
Portata in spazio aperto / Radio range in open space	100 m
Grado di protezione / Protection level	IP 44

## ATX2/S

Modulo bidirezionale con sirena interna per comandare fino a 8 sirene Doge wireless.  
Two-way radio device with internal sounder able to control up to 8 Doge wireless sounders.

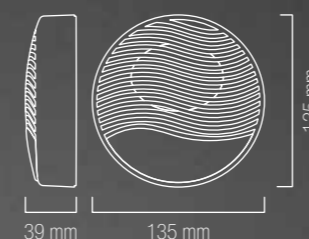

3 LED anomalia e display sirene memorizzate  
3 anomaly LEDs and display to visualize memorized sounders

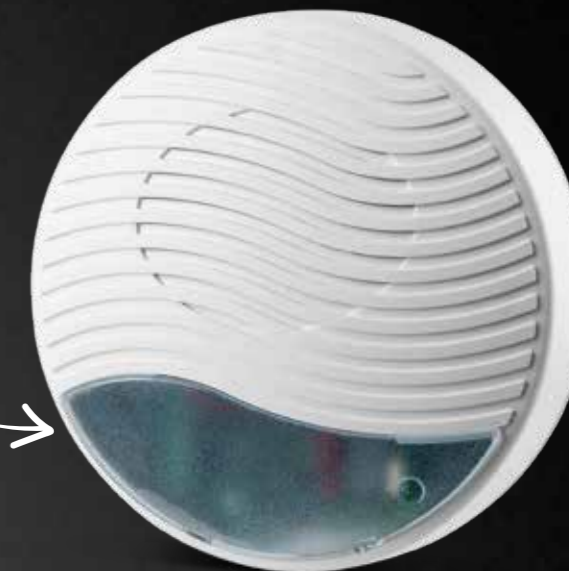

## ATX3

Modulo bidirezionale senza sirena interna per comandare fino a 8 sirene Doge wireless.  
Two-way radio device able to control up to 8 Doge wireless sounders.



3 LED anomalia e display sirene memorizzate  
3 anomaly LEDs and display to visualize memorized sounders

LED generale anomalia / General anomaly LED

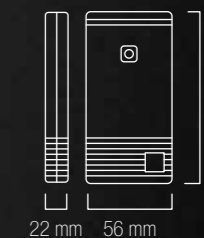

## DATI TECNICI TECHNICAL DATA

### ATX2/S – ATX3

Alimentazione / Power supply	12 Vdc
Assorbimento a riposo / Standby consumption	100 microA
Assorbimento in allarme / Alarm consumption	110 mA MAX
Frequenza sirena piezoelettrica / Piezoelectric sounder frequency	2600 Hz ÷ 3600 Hz
Frequenza di trasmissione / Receiving frequency	433.92 MHz
Frequenza di ricezione / Optical signaling	433.92 MHz
Temperatura di funzionamento / Temperature	+5°C ÷ +40°C
Grado di protezione / Protection level	IP 3X

## COLORI COLOURS

Coperchio Esterno  
External cover

- Avorio / Ivory
- Acciaio / Grey
- Champagne / Champagne
- Celeste / Light blue
- Rame / Copper
- Bronzo / Bronze
- Rosso / Red
- Cromo / Chromium  
Colore disponibile con supplemento  
Colour available at extra cost

Calotte  
Flash covers

- Arancio / Orange
- Fumè / Smoke grey

## PERSONALIZZAZIONI CUSTOMIZATIONS

Supplemento per colore cromo  
Extra cost for chromium version

Supplemento per colorazioni personalizzate (min. 100 pz.)  
Extra cost for customized colours (100 pcs. min.)

Finiture speciali - colori "TECH"  
Special finishings - "TECH" colours

Adesivi (min. 200 pz.) Serigrafie (min. 50 pz.)  
Decalco (min. 50 pz.)  
Embossed stickers (200 pcs. min.) Serigraphies (50 pcs. min.) Decal (50 pcs. min.)

## MODELLI MODELS

		PEZZI / PIECES
<b>DOGE AS1</b>	Sirena wireless con sistema antischiuma e antishock con pacco batteria TBA 7.5 Wireless sounder with anti-foam and anti-shock protection with TBA 7.5 battery pack	4
<b>DOGE AS1/P</b>	Sirena wireless con sistema antischiuma, antishock e antiperforazione con pacco batteria TBA 7.5 Wireless sounder with anti-foam, anti-shock and anti-drilling protection with TBA 7.5 battery pack	4
<b>ATX2/S</b>	Dispositivo ricetrasmittente bidirezionale con sirena interna Two-way radio transmitting device with internal sounder	4
<b>ATX3</b>	Dispositivo ricetrasmittente bidirezionale senza sirena interna / Two-way radio transmitting device without internal sounder	4

## KIT KITS

		PEZZI / PIECES
<b>KIT 1</b>	Doge AS1 + ATX2/S + TBA 7.5	4
<b>KIT 1/P</b>	Doge AS1/P + ATX2/S + TBA 7.5	4
<b>KIT 2</b>	Doge AS1 + ATX3 + TBA 7.5	4
<b>KIT 2/P</b>	Doge AS1/P + ATX3 + TBA 7.5	4

## RICAMBI ACCESSORY

Coperchio esterno verniciato  
External cover in painted ABS

Calotta per lampeggiante in policarbonato.  
Colori disponibili: arancio e fumè  
Polycarbonate cover for flashing device.  
Available colours: orange and smoke grey

Pacchetto batterie alcaline 7.5 V size "D"  
Ultra dimension "D" 7.5 V alkaline battery pack



# HOLA

Hola è una sirena dal design e dalle colorazioni ricercate, ma allo stesso tempo tanto lineari da adattarsi a qualsiasi tipo di ambiente, dai più rustici ai più moderni. La possibilità di montaggio orizzontale o verticale e le sue dimensioni rivisitate, favoriscono una maggiore libertà di installazione e ampie possibilità di personalizzazione.

Hola is a smart and simple design sounder with special colours developed to suit any kind of context, from the country-stylish to the most modern. Hola can be installed both vertically and horizontally and it offers a wide range of personalization possibilities.

Sistema antischiuma e antishock brevettato  
Patented anti-foam and anti-shock system

Innovativo sistema antiperforazione  
Innovative anti-drilling system

Design studiato per lasciare spazio a infinite possibilità di personalizzazione  
Design studied to allow a wide range of possible personalization

Lampeggiante a LED comandabile separatamente  
Separately controllable LED flashing unit

## DI SERIE STANDARD FEATURES

ON/OFF positivo e negativo settabile da dip switch  
Positive and negative ON/OFF settable by dip switch

Comando di interruzione suono  
Command for sound interruption

Controllo batteria secondo normativa EN 50131  
Battery control according to EN 50131 standard

Segnalazione ottica e acustica impianto ON/OFF  
Optical and acoustic ON/OFF signaling

4 Suoni programmabili e 4 temporizzazioni settabili da dip switch  
4 programmable sounds and 4 timings settable by dip switch

Bolla di centratura / Spirit level

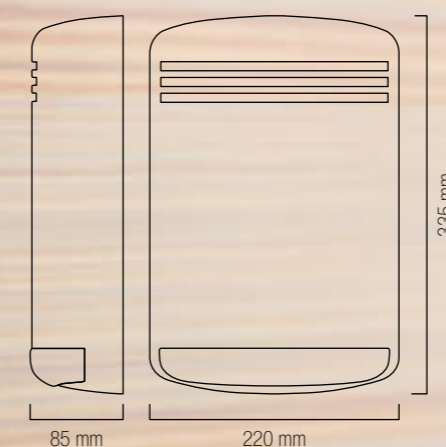

## MONTAGGIO MOUNTING

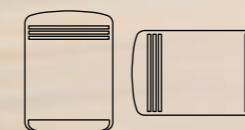

## COLORI COLOURS

### Coperchio Esterno External cover

- Bianco opaco / Matt white
- Grigio opaco / Matt grey
- Bianco perlato / Pearly white
- Champagne / Champagne
- Rame / Copper
- Cromo / Chromium  
Colore disponibile con supplemento  
Colour available at extra cost

### Calotte Flash covers

- Arancio / Orange
- Azzurro / Light blue
- Fumè / Smoke grey

## PERSONALIZZAZIONI CUSTOMIZATIONS

Supplemento per colore cromo  
Extra cost for chromium version

Supplemento per colorazioni personalizzate (min. 100 pz.)  
Extra cost for customized colours (100 pcs. min.)

Finiture speciali - colori "TECH"  
Special finishings - "TECH" colours

Adesivi (min. 200 pz.) Serigrafie (min. 50 pz.)  
Decalco (min. 50 pz.)  
Embossed stickers (200 pcs. min.) Serigraphies (50 pcs. min.)  
Decal (50 pcs. min.)



	HOLA L	HOLA LS	HOLA LSP	CIVETTA / DUMMY
Alimentazione / Power supply: <b>13.8 Vdc</b>	•	•	•	
Assorbimento MAX dalla centrale MAX consumption from alarm control panel: <b>800 mA</b>	•	•	•	
Assorbimento a riposo / Standby consumption: <b>15 mA</b>	•	•	•	
Assorbimento in allarme dalla batteria Battery consumption in alarm: <b>1.4 A</b>	•	•	•	
Assorbimento LED / LED consumption: <b>100 mA</b>	•	•	•	
Frequenza fondamentale / Fundamental frequency: <b>1432 Hz</b>	•	•	•	
Potenza sonora MAX a 1 m / Sound level MAX at 1 m: <b>dB</b>	<b>106.2</b>	<b>109.5</b>	<b>109.5</b>	
Memoria allarme / Alarm memory	•	•	•	
Possibilità di comando a 3 o 2 fili 3 or 2 wires control option	•	•	•	
Limite allarmi giornalieri / allarmi infiniti (settabili da dip switch) MAX daily / infinite alarms (settable by dip switch)	•	•	•	
Test sirena e batteria comandabile da remoto Remote control of sounder and battery test	•	•	•	
Uscita anomalia / Anomaly output	•	•	•	
LED interno per individuazione anomalia (su circuito sirena) Anomaly signaling LED (on sounder board)	•	•	•	
Sistema antiapertura e antirimozione a doppio tamper Anti-opening and anti-removal double-tamper system	•	•	•	
Sistema antischiuma e antishock brevettato a doppia rilevazione Patented double-detection anti-foam and anti-shock device		•	•	
Sistema antiperforazione / Anti-drilling system			•	
Grado di sicurezza / Security level	<b>3</b>	<b>3</b>	<b>4</b>	
Classe ambientale / Environmental class: <b>IV</b>	•	•	•	
Grado protezione / Protection level: <b>IP 44</b>	•	•	•	
Temperatura di funzionamento / Operating temperature: <b>-25°C ÷ +55°C</b>	•	•	•	
Resistenza all'impatto / Impact resistance: <b>IK 08</b>	•	•	•	
Batteria / Battery: <b>12 V 2.1 Ah Pb o/or 12 V 1.2 Ah Pb</b>	•	•	•	
Certificazione di Conformità alla Normativa <b>EN 50131-4</b> Complying with <b>EN 50131-4</b> Standard	•	•	•	
 Marchio / Marks: <b>IMQ Sistemi di sicurezza</b>	•	•	•	
 Marchio / Marks: <b>INCERT</b>	•	•	•	
Peso (gr.) / Weight (gr.)	<b>1743</b>	<b>1715</b>	<b>1752</b>	<b>859</b>
Pezzi a confezione / Pieces per pack	<b>5</b>	<b>5</b>	<b>5</b>	<b>5</b>



# Rio

Design originale e linee sinuose per la sirena Rio, dotata di lampeggiante a 10 LED ad alta luminosità che rende ottimale la segnalazione ottica dello stato dell'impianto.

Original design and curvy lines for Rio, the sounder equipped with a 10 high-brightness LED flashing unit that optimizes the optical signaling of the system state.

## DI SERIE

### STANDARD FEATURES

ON/OFF positivo e negativo settabile da dip switch  
Positive and negative ON/OFF settable by dip switch

Comando di interruzione suono  
Command for sound interruption

Controllo batteria secondo normativa EN 50131  
Battery control according to EN 50131 standard

Segnalazione ottica impianto ON/OFF  
Optical ON/OFF signaling

2 Suoni programmabili e 2 temporizzazioni settabili da dip switch  
2 programmable sounds and 2 timings settable by dip switch

Bolla di centratura / Spirit level

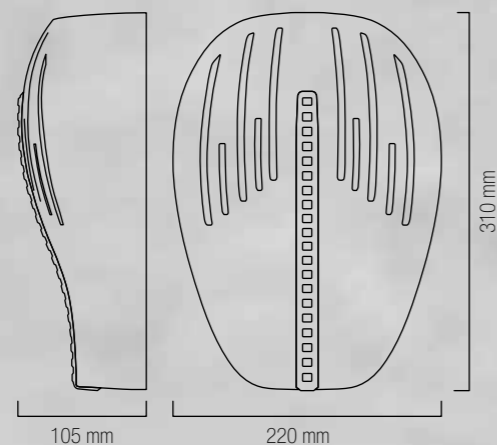

**Sistema antischiuma e antishock brevettato**  
Patented anti-foam and anti-shock system

**Lampeggiante a 10 LED ad alta luminosità**  
Flashing unit with 10 high-brightness LEDs

**Gancio di sicurezza interno**  
Internal safety hook



## GANCIO DI SICUREZZA SAFETY HOOK

L'innovativo ed esclusivo sistema Venitem, pratico e veloce per una facile installazione della sirena.  
Innovative and exclusive safety hook for an easy and quick mounting of the sounder.

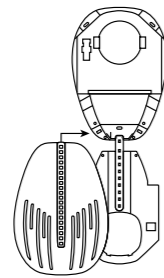

## COLORI COLOURS

Coperchio Esterno  
External cover

- Bianco opaco / Matt white
- Argento opaco / Matt silver
- Bianco perlato / Pearly white
- Cromo /  
Colore disponibile con supplemento  
Colour available at extra cost

Calotte  
Flash covers

- Arancio / Orange
- Azzurro / Light blue

## PERSONALIZZAZIONI CUSTOMIZATIONS

Supplemento per colore cromo  
Extra cost for chromium version

Supplemento per colorazioni personalizzate  
(min. 100 pz.)  
Extra cost for customized colours (100 pcs. min.)

Finiture speciali - colori "TECH"  
Special finishings - "TECH" colours

Adesivi (min. 200 pz.) Serigrafie (min. 50 pz.)  
Decalco (min. 50 pz.)  
Embossed stickers (200 pcs. min.) Serigraphies (50 pcs. min.)  
Decal (50 pcs. min.)



	RIO L	RIO LS	CIVETTA / DUMMY
Alimentazione / Power supply: <b>13.8 Vdc</b>	•	•	
Assorbimento MAX dalla centrale MAX consumption from alarm control panel: <b>600 mA</b>	•	•	
Assorbimento a riposo / Standby consumption: <b>15 mA</b>	•	•	
Assorbimento in allarme dalla batteria Battery consumption in alarm: <b>1.4 A</b>	•	•	
Assorbimento LED / LED consumption: <b>100 mA</b>	•	•	
Frequenza fondamentale / Fundamental frequency: <b>1475 Hz</b>	•	•	
Potenza sonora MAX a 1 m / Sound level MAX at 1 m: <b>dB</b>	<b>112.9</b>	<b>113.2</b>	
Memoria allarme / Alarm memory	•	•	
Possibilità di comando a 3 o 2 fili 3 or 2 wires control option	•	•	
Limite allarmi giornalieri / allarmi infiniti (settabili da dip switch) MAX daily / infinite alarms (settable by dip switch)	•	•	
Test sirena e batteria comandabile da remoto Remote control of sounder and battery test	•	•	
Uscita anomalia / Anomaly output	•	•	
LED interno per individuazione anomalia (su circuito sirena) Anomaly signaling LED (on sounder board)	•	•	
Sistema antiapertura e antirimozione a doppio tamper Anti-opening and anti-removal double-tamper system	•	•	
Sistema antischiuma e antishock brevettato a doppia rilevazione Patented double-detection anti-foam and anti-shock device		•	
Grado di sicurezza / Security level	<b>3</b>	<b>3</b>	
Classe ambientale / Environmental class: <b>IV</b>	•	•	
Grado protezione / Protection level: <b>IP 44</b>	•	•	
Temperatura di funzionamento / Operating temperature: <b>-25°C ÷ +55°C</b>	•	•	
Resistenza all'impatto / Impact resistance: <b>IK 08</b>	•	•	
Batteria / Battery: <b>12 V 2.1 Ah Pb o/or 12 V 1.2 Ah Pb</b>	•	•	
Certificazione di Conformità alla Normativa <b>EN 50131-4</b> Complying with <b>EN 50131-4</b> Standard	•	•	
Marchio / Marks: <b>IMQ Sistemi di sicurezza</b>	•	•	
Marchio / Marks: <b>INCERT</b>	•	•	
Peso (gr.) / Weight (gr.)	<b>1889</b>	<b>1896</b>	<b>811</b>
Pezzi a confezione / Pieces per pack	<b>6</b>	<b>6</b>	<b>6</b>

# RONDÒ



Rondò è la sirena da esterno ideata per garantire un rapporto estremamente vantaggioso tra estetica e ricerca tecnica, unendo un design originale ad accorgimenti di tipo pratico.

Rondò is the outdoor sounder created to grant the most cost-efficient solution in terms of design and technological research. Rondò joins great design and useful practical details.

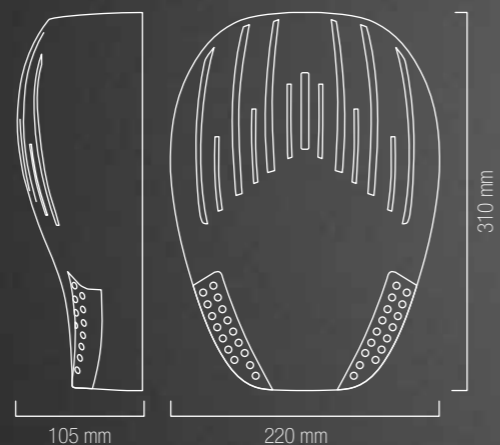

## DI SERIE STANDARD FEATURES

**ON/OFF positivo e negativo settabile da dip switch**  
Positive and negative ON/OFF settable by dip switch

**Controllo batteria secondo normativa EN 50131**  
Battery control according to EN 50131 standard

**Segnalazione ottica impianto ON/OFF**  
Optical ON/OFF signaling

**2 Suoni programmabili e 2 temporizzazioni settabili da dip switch**  
2 programmable sounds and 2 timings settable by dip switch

**Bolla di centratura / Spirit level**

## GANCIO DI SICUREZZA SAFETY HOOK

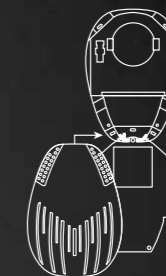

L'innovativo ed esclusivo sistema Venitem, pratico e veloce per una facile installazione della sirena.

Innovative and exclusive safety hook for an easy and quick mounting of the sounder.



## COLORI COLOURS

### Coperchio Esterno External cover

- Bianco / White
- Grigio metallizzato / Metal grey
- Cromo / Chromium  
Colore disponibile con supplemento  
Colour available at extra cost

### Calotte Flash covers

- Arancio / Orange
- Fumè / Smoke grey

## PERSONALIZZAZIONI CUSTOMIZATIONS

Supplemento per colore cromo  
Extra cost for chromium version

Supplemento per colorazioni personalizzate (min. 100 pz.)  
Extra cost for customized colours (100 pcs. min.)

Finiture speciali - colori "TECH"  
Special finishings - "TECH" colours

Adesivi (min. 200 pz.) Serigrafie (min. 50 pz.)  
Decalco (min. 50 pz.)  
Embossed stickers (200 pcs. min.) Serigraphies (50 pcs. min.)  
Decal (50 pcs. min.)



	RONDÒ L	RONDÒ LS	CVIETTA / DUMMY
Alimentazione / Power supply: <b>13.8 Vdc</b>	•	•	
Assorbimento MAX dalla centrale MAX consumption from alarm control panel: <b>600 mA</b>	•	•	
Assorbimento a riposo / Standby consumption: <b>15 mA</b>	•	•	
Assorbimento in allarme dalla batteria Battery consumption in alarm: <b>1.4 A</b>	•	•	
Assorbimento LED / LED consumption: <b>100 mA</b>	•	•	
Frequenza fondamentale / Fundamental frequency: <b>1475 Hz</b>	•	•	
Potenza sonora MAX a 1 m / Sound level MAX at 1 m: <b>dB</b>	<b>108.4</b>	<b>109.2</b>	
Memoria allarme / Alarm memory	•	•	
Possibilità di comando a 3 o 2 fili 3 or 2 wires control option	•	•	
Limite allarmi giornalieri / allarmi infiniti (settabili da dip switch) MAX daily / infinite alarms (settable by dip switch)	•	•	
Test sirena e batteria comandabile da remoto Remote control of sounder and battery test	•	•	
Uscita anomalia / Anomaly output	•	•	
LED interno per individuazione anomalia (su circuito sirena) Anomaly signaling LED (on sounder board)	•	•	
Sistema antiapertura e antirimozione a doppio tamper Anti-opening and anti-removal double-tamper system	•	•	
Sistema antischiuma e antishock brevettato a doppia rilevazione Patented double-detection anti-foam and anti-shock device			•
Grado di sicurezza / Security level	<b>3</b>	<b>3</b>	
Classe ambientale / Environmental class: <b>IV</b>	•	•	
Grado protezione / Protection level: <b>IP 44</b>	•	•	
Temperatura di funzionamento / Operating temperature: <b>-25°C ÷ +55°C</b>	•	•	
Resistenza all'impatto / Impact resistance: <b>IK 08</b>	•	•	
Batteria / Battery: <b>12 V 2.1 Ah Pb o/or 12 V 1.2 Ah Pb</b>	•	•	
Certificazione di Conformità alla Normativa <b>EN 50131-4</b> Complying with <b>EN 50131-4</b> Standard	•	•	
Peso (gr.) / Weight (gr.)	<b>1594</b>	<b>1614</b>	<b>813</b>
Pezzi a confezione / Pieces per pack	<b>6</b>	<b>6</b>	<b>6</b>

# TRIADE

La capostipite delle sirene con coperchio esterno in ABS verniciato, robustezza strutturale, versatilità estetica.

The first alarm siren with painted ABS cover, structural robustness, complete aesthetic versatility.

**Coperchio esterno in ABS verniciato**

External cover in painted ABS



Struttura e coperchio interno in  
Structure and internal cover

## DI SERIE STANDARD FEATURES

ON/OFF positivo e negativo  
Positive and negative ON/OFF settings

Comando di interruzione suono  
Command for sound interruption

Controllo batteria secondo norme  
Battery control according to EN 50131-4

Segnalazione ottica e acustica  
Optical and acoustic ON/OFF signaling

2 Suoni programmabili e 2 temporizzazioni settabili da dip switch  
2 programmable sounds and 2 timings settable by dip switch

Bolla di centratura / Spirit level



TRIADE Q

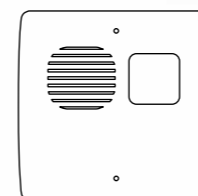

Versione con lampeggiante quadrato  
Version with squared flash cover

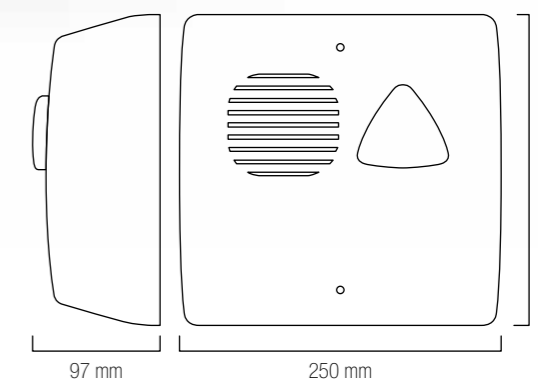

## COLORI COLOURS

Coperchio Esterno External cover		Bianco / White
		Acciaio / Grey
		Champagne / Champagne solo mod. con lampeggiante triangolare only for triangular flashing light model
Calotte Flash covers		Arancio / Orange
		Fumè / Smoke grey

## PERSONALIZZAZIONI CUSTOMIZATIONS

Supplemento per colorazioni personalizzate  
(min. 100 pz.)  
Extra cost for customized colours (100 pcs. min.)

Finiture speciali - colori "TECH"  
Special finishings - "TECH" colours

Adesivi (min. 200 pz.) Serigrafie (min. 50 pz.)  
Decalco (min. 50 pz.)  
Embossed stickers (200 pcs. min.)  
Serigraphies (50 pcs. min.) Decal (50 pcs. min.)

## RICAMBI ACCESSORY

Coperchio esterno verniciato - Foro per lampeggiante triangolare  
External cover in painted ABS - Triangular shaped flashing unit

Coperchio esterno verniciato - Foro per lampeggiante quadrato  
External cover in painted ABS - Squared shaped flashing unit

Calotta per lampeggiante triangolare in policarbonato  
Colori disponibili: arancio e fumè  
Polycarbonate triangular cover for flashing device  
Available colours: orange and smoke grey

Calotta per lampeggiante quadrato in policarbonato  
Colori disponibili: arancio e fumè  
Polycarbonate squared cover for flashing device  
Available colours: orange and smoke grey



	TRIADE L	TRIADE QL	TRIADE LS	TRIADE QLS	CIVETTA / DUMMY
Alimentazione / Power supply: <b>13.8 Vdc</b>	•	•	•	•	
Assorbimento MAX dalla centrale MAX consumption from alarm control panel: <b>800 mA</b>	•	•	•	•	
Assorbimento a riposo / Standby consumption: <b>15 mA</b>	•	•	•	•	
Assorbimento in allarme dalla batteria Battery consumption in alarm: <b>1.4 A</b>	•	•	•	•	
Assorbimento LED / LED consumption: <b>90 mA</b>	•	•	•	•	
Frequenza fondamentale / Fundamental frequency: <b>1600 Hz</b>	•	•	•	•	
Potenza sonora MAX a 1 m / Sound level MAX at 1 m: <b>dB</b>	115	115	113.1	113.1	
Memoria allarme / Alarm memory	•	•	•	•	
Possibilità di comando a 3 o 2 fili 3 or 2 wires control option	•	•	•	•	
Limite allarmi giornalieri / allarmi infiniti (settabili da ponticello) MAX daily / infinite alarms (settable by jumper)	•	•	•	•	
Test sirena e batteria comandabile da remoto Remote control of sounder and battery test	•	•	•	•	
Uscita anomalia / Anomaly output	•	•	•	•	
LED interno per individuazione anomalia (su circuito sirena) Anomaly signaling LED (on sounder board)	•	•	•	•	
Sistema antiapertura e antirimozione a doppio tamper Anti-opening and anti-removal double-tamper system	•	•	•	•	
Sistema antischiama e antishock brevettato a doppia rilevazione Patented double-detection anti-foam and anti-shock device			•	•	
Grado di sicurezza / Security level	3	3	3	3	
Classe ambientale / Environmental class: <b>IV</b>	•	•	•	•	
Grado protezione / Protection level: <b>IP 44</b>	•	•	•	•	
Temperatura di funzionamento / Operating temperature: <b>-25°C ÷ +55°C</b>	•	•	•	•	
Resistenza all'impatto / Impact resistance: <b>IK 08</b>	•	•	•	•	
Batteria / Battery: <b>12 V 2.1 Ah Pb o/or 12 V 1.2 Ah Pb</b>	•	•	•	•	
Certificazione di Conformità alla Normativa <b>EN 50131-4</b> Complying with <b>EN 50131-4</b> Standard	•	•	•	•	
 Marchio / Marks: <b>IMQ Sistemi di sicurezza</b>	•	•	•	•	
 Marchio / Marks: <b>INCERT</b>	•	•	•	•	
Peso (gr.) / Weight (gr.)	2082	2085	2057	2050	1054
Pezzi a confezione / Pieces per pack	6	6	6	6	6

# RIALTO

Sirena d'allarme in metallo speciale verniciato a polveri di poliestere, capace di garantire un'ottima durata nel tempo anche in presenza di condizioni climatiche sfavorevoli. Disponibile anche nella versione INOX.

Alarm sounder in special metal painted using polyester powder coating, able to assure a long life even in case of very bad weather conditions. Available also in stainless steel version.

## DI SERIE STANDARD FEATURES

ON/OFF positivo e negativo settabile da dip switch  
Positive and negative ON/OFF settable by dip switch

Comando di interruzione suono  
Command for sound interruption

Controllo batteria secondo normativa EN 50131  
Battery control according to EN 50131 standard

Segnalazione ottica e acustica impianto ON/OFF  
Optical and acoustic ON/OFF signaling

2 Suoni programmabili e 2 temporizzazioni settabili da dip switch  
2 programmable sounds and 2 timings settable by dip switch

Bolla di centratura / Spirit level

Sistema antischiuma e antishock brevettato  
Patented anti-foam and anti-shock system



Coperchio esterno in metallo  
verniciato o acciaio INOX  
External cover in painted metal or  
stainless steel

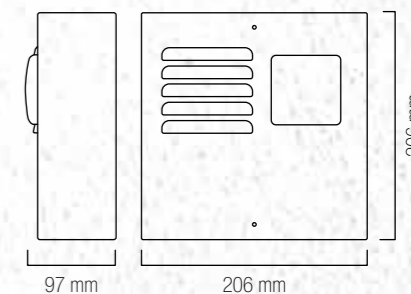

## COLORI COLOURS

Coperchio Esterno  
External cover

- Bianco / White  
 Acciaio INOX  
Stainless steel

Calotte  
Flash covers

- Arancio / Orange  
 Fumè / Smoke grey

## RICAMBI ACCESSORY

Coperchio esterno in metallo verniciato  
External cover in painted metal



Coperchio esterno INOX  
Stainless steel external cover

Calotta per lampeggiante in policarbonato  
Colori disponibili: arancio e fumè  
Polycarbonate cover for flashing device  
Available colours: orange and smoke grey

## PERSONALIZZAZIONI CUSTOMIZATIONS

Adesivi (min. 200 pz.)  
Serigrafie (min. 50 pz.)  
Decalco (min. 50 pz.)  
Embossed stickers (200 pcs. min.)  
Serigraphies (50 pcs. min.)  
Decal (50 pcs. min.)



	RIALTO	RIALTO L	RIALTO X	RIALTO LS	RIALTO LSX	CIVETTA / DUMMY	CIVETTA INOX DUMMY INOX
Alimentazione / Power supply: <b>13.8 Vdc</b>	●	●	●	●	●		
Assorbimento MAX dalla centrale MAX consumption from alarm control panel: <b>800 mA</b>	●	●	●	●	●		
Assorbimento a riposo / Standby consumption: <b>15 mA</b>	●	●	●	●	●		
Assorbimento in allarme dalla batteria Battery consumption in alarm: <b>1.4 A</b>	●	●	●	●	●		
Assorbimento LED / LED consumption: <b>90 mA</b>		●	●	●	●		
Frequenza fondamentale / Fundamental frequency: <b>1600 Hz</b>	●	●	●	●	●		
Potenza sonora MAX a 1 m / Sound level MAX at 1 m: <b>dB</b>	115	115	115	115	117.1		
Memoria allarme / Alarm memory	●	●	●	●	●		
Possibilità di comando a 3 o 2 fili 3 or 2 wires control option	●	●	●	●	●		
Limite allarmi giornalieri / allarmi infiniti (settabili da ponticello) MAX daily / infinite alarms (settable by jumper)	●	●	●	●	●		
Test sirena e batteria comandabile da remoto Remote control of sounder and battery test	●	●	●	●	●		
Uscita anomalia / Anomaly output	●	●	●	●	●		
LED interno per individuazione anomalia (su circuito sirena) Anomaly signaling LED (on sounder board)	●	●	●	●	●		
Sistema antiapertura e antirimozione a doppio tamper Anti-opening and anti-removal double-tamper system	●	●	●	●	●		
Sistema antischiuma e antishock brevettato a doppia rilevazione Patented double-detection anti-foam and anti-shock device				●	●		
Grado di sicurezza / Security level		3	3	3	3		
Classe ambientale / Environmental class: <b>IV</b>	●	●	●	●	●		
Grado protezione / Protection level: <b>IP 44</b>	●	●	●	●	●		
Temperatura di funzionamento / Operating temperature: <b>-25°C ÷ +55°C</b>	●	●	●	●	●		
Resistenza all'impatto / Impact resistance: <b>IK 08</b>	●	●	●	●	●		
Batteria / Battery: <b>12 V 2.1 Ah Pb o/or 12 V 1.2 Ah Pb</b>	●	●	●	●	●		
Certificazione di Conformità alla Normativa <b>EN 50131-4</b> Complying with <b>EN 50131-4</b> Standard		●	●	●	●		
 Marchio / Marks: <b>IMQ Sistemi di sicurezza</b>		●	●	●	●		
 Marchio / Marks: <b>INCERT</b>		●	●	●	●		
Peso (gr.) / Weight (gr.)	2550	2561	2593	2514	2488	1563	1560
Pezzi a confezione / Pieces per pack	6	6	6	6	6	6	6



# LIDO

Robustezza ed affidabilità per una sirena senza tempo. Disponibile in versione INOX o in metallo verniciato con speciale trattamento capace di assicurare un'ottima durata nel tempo.

Robustness and reliability for a timeless outdoor sounder. LIDO is available in stainless steel or in metal painted through a special treatment able to ensure an excellent durability.



Sistema antischiuma e antishock brevettato  
Patented anti-foam and anti-shock system

Coperchio esterno in metallo verniciato o acciaio INOX  
External cover in painted metal or stainless steel

## DI SERIE STANDARD FEATURES

ON/OFF positivo e negativo settabile da dip switch  
Positive and negative ON/OFF settable by dip switch

Comando di interruzione suono  
Command for sound interruption

Controllo batteria secondo normativa EN 50131  
Battery control according to EN 50131 standard

Segnalazione ottica e acustica impianto ON/OFF  
Optical and acoustic ON/OFF signaling

2 Suoni programmabili e 2 temporizzazioni settabili da dip switch  
2 programmable sounds and 2 timings settable by dip switch

Bolla di centratura / Spirit level

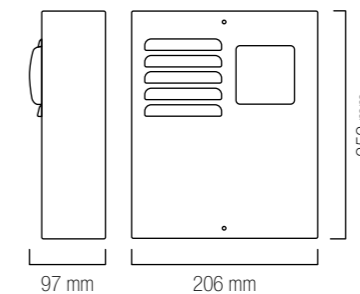

## COLORI COLOURS

Coperchio Esterno External cover	<input type="radio"/>	Bianco / White
	<input type="radio"/>	Acciaio INOX Stainless steel
Calotte Flash covers	<input type="radio"/>	Arancio / Orange
	<input type="radio"/>	Fumè / Smoke grey

## PERSONALIZZAZIONI CUSTOMIZATIONS

Adesivi (min. 200 pz.)  
Serigrafie (min. 50 pz.)  
Decalco (min. 50 pz.)  
Embossed stickers (200 pcs. min.)  
Serigraphies (50 pcs. min.)  
Decal (50 pcs. min.)

## RICAMBI ACCESSORY

Coperchio esterno in metallo verniciato  
External cover in painted metal

Coperchio esterno INOX  
Stainless steel external cover

Calotta per lampeggiante in policarbonato  
Colori disponibili: arancio e fumè  
Polycarbonate cover for flashing device  
Available colours: orange and smoke grey



	LIDO L	LIDO X	LIDO LS	LIDO LSX	CIVETTA / DUMMY	CIVETTA INOX DUMMY INOX
Alimentazione / Power supply: <b>13.8 Vdc</b>	•	•	•	•		
Assorbimento MAX dalla centrale MAX consumption from alarm control panel: <b>800 mA</b>	•	•	•	•		
Assorbimento a riposo / Standby consumption: <b>15 mA</b>	•	•	•	•		
Assorbimento in allarme dalla batteria Battery consumption in alarm: <b>1.4 A</b>	•	•	•	•		
Assorbimento LED / LED consumption: <b>90 mA</b>	•	•	•	•		
Frequenza fondamentale / Fundamental frequency: <b>1600 Hz</b>	•	•	•	•		
Potenza sonora MAX a 1 m / Sound level MAX at 1 m: <b>dB</b>	115	115	115	115		
Memoria allarme / Alarm memory	•	•	•	•		
Possibilità di comando a 3 o 2 fili 3 or 2 wires control option	•	•	•	•		
Limite allarmi giornalieri / allarmi infiniti (settabili da ponticello) MAX daily / infinite alarms (settable by jumper)	•	•	•	•		
Test sirena e batteria comandabile da remoto Remote control of sounder and battery test	•	•	•	•		
Uscita anomalia / Anomaly output	•	•	•	•		
LED interno per individuazione anomalia (su circuito sirena) Anomaly signaling LED (on sounder board)	•	•	•	•		
Sistema antiapertura e antrimozione a doppio tamper Anti-opening and anti-removal double-tamper system	•	•	•	•		
Sistema antischiama e antishock brevettato a doppia rilevazione Patented double-detection anti-foam and anti-shock device			•	•		
Grado di sicurezza / Security level	3	3	3	3		
Classe ambientale / Environmental class: <b>4</b>	•	•	•	•		
Grado protezione / Protection level: <b>IP 44</b>	•	•	•	•		
Temperatura di funzionamento / Operating temperature: <b>-25°C ÷ +55°C</b>	•	•	•	•		
Resistenza all'impatto / Impact resistance: <b>IK 08</b>	•	•	•	•		
Batteria / Battery: <b>12 V 2.1 Ah Pb o/or 12 V 7 Ah Pb</b>	•	•	•	•		
Certificazione di Conformità alla Normativa <b>EN 50131-4</b> Complying with <b>EN 50131-4</b> Standard	•	•	•	•		
 Marchio / Marks: <b>IMQ Sistemi di sicurezza</b>	•	•	•	•		
 Marchio / Marks: <b>INCERT</b>	•	•	•	•		
Peso (gr.) / Weight (gr.)	2951	2879	2900	2829	1812	1740
Pezzi a confezione / Pieces per pack	6	6	6	6	6	6



Sistema antischiuma e antishock brevettato  
Patented anti-foam and anti-shock system

Coperchio esterno in metallo verniciato o acciaio INOX  
External cover in painted metal or stainless steel

# ECO 800

 by  **SYLCO**  
the sound of security  
by Venitem Group

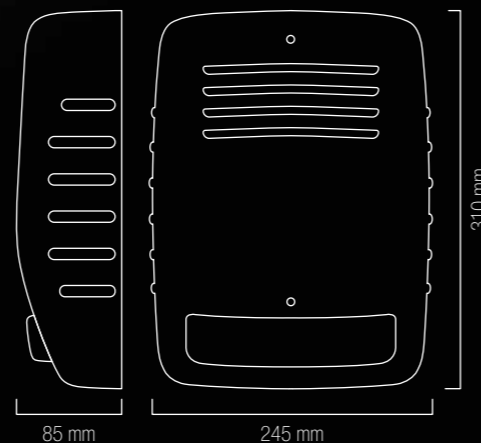

Una sirena dalla struttura solida che consente un perfetto funzionamento anche in caso di infiltrazioni e difficili condizioni climatiche. Disponibile con coperchio esterno in metallo verniciato o in acciaio INOX.

An alarm sounder with a solid structure allowing perfect functioning even in case of infiltrations and hard weather conditions. ECO 800 is available with external cover in painted metal or stainless steel.





## COLORI COLOURS

Coperchio Esterno  
External cover

-  Bianco / White
-  Acciaio INOX / Stainless steel

## Calotte

Flash covers

-  Arancio / Orange
-  Fumè / Smoke grey
-  Azzurro / Light blue

## PERSONALIZZAZIONI CUSTOMIZATIONS

Adesivi (min. 200 pz.)  
Serigrafie (min. 50 pz.)  
Decalco (min. 50 pz.)  
Embossed stickers (200 pcs. min.)  
Serigraphies (50 pcs. min.)  
Decal (50 pcs. min.)

EN 50131-4



	ECO 800	ECO 800 LS	ECO 800 X	ECO 800 LSX
Alimentazione / Power supply: <b>13.8 Vdc</b>	•	•	•	•
Assorbimento MAX dalla centrale MAX consumption from alarm control panel: <b>600 mA</b>	•	•	•	•
Assorbimento a riposo / Standby consumption: <b>15 mA</b>	•	•	•	•
Assorbimento in allarme dalla batteria Battery consumption in alarm: <b>1.4 A</b>	•	•	•	•
Assorbimento LED / LED consumption: <b>100 mA</b>	•	•	•	•
Frequenza fondamentale / Fundamental frequency: <b>1475 Hz</b>	•	•	•	•
Potenza sonora MAX a 1 m / Sound level MAX at 1 m: <b>dB</b>	110.2	106	110.2	106
Memoria allarme / Alarm memory	•	•	•	•
Possibilità di comando a 3 o 2 fili 3 or 2 wires control option	•	•	•	•
Limite allarmi giornalieri / allarmi infiniti (settabili da dip switch) MAX daily / infinite alarms (settable by dip switch)	•	•	•	•
Test sirena e batteria comandabile da remoto Remote control of sounder and battery test	•	•	•	•
Uscita anomalia / Anomaly output	•	•	•	•
LED interno per individuazione anomalia (su circuito sirena) Anomaly signaling LED (on sounder board)	•	•	•	•
Sistema antiapertura e antirimozione a doppio tamper Anti-opening and anti-removal double-tamper system	•	•	•	•
Sistema antischiuma e antishock brevettato a doppia rilevazione Patented double-detection anti-foam and anti-shock device		•		•
Grado di sicurezza / Security level	3	3	3	3
Classe ambientale / Environmental class: <b>IV</b>	•	•	•	•
Grado protezione / Protection level: <b>IP 44</b>	•	•	•	•
Temperatura di funzionamento / Operating temperature: <b>-25°C ÷ +55°C</b>	•	•	•	•
Resistenza all'impatto / Impact resistance: <b>IK 08</b>	•	•	•	•
Batteria / Battery: <b>12 V 2.1 Ah Pb o/or 12 V 1.2 Ah Pb</b>	•	•	•	•
Certificazione di Conformità alla Normativa <b>EN 50131-4</b> Complying with <b>EN 50131-4</b> Standard	•	•	•	•
 Marchio / Marks: <b>INCERT</b>	•	•	•	•
Peso (gr.) / Weight (gr.)	3099	3071	2990	2980
Pezzi a confezione / Pieces per pack	5	5	5	5



Sistema antischiuma e antishock brevettato  
Patented anti-foam and anti-shock system

Coperchio esterno in metallo verniciato o acciaio INOX  
External cover in painted metal or stainless steel

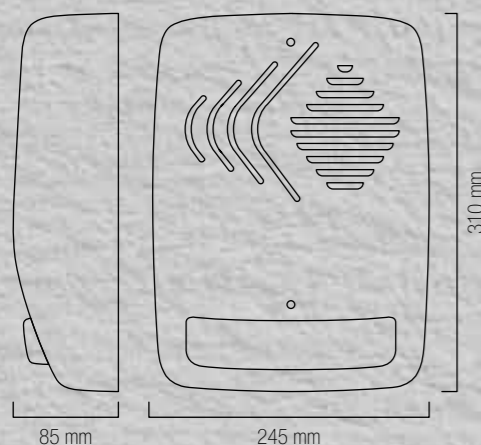

## ECO 700 by SYLCO

the sound of security  
by Verbatim Group

La sirena d'allarme realizzata per operare al massimo delle prestazioni anche in presenza di difficili condizioni climatiche.

ECO 700 is the alarm sounder designed to offer top level performance even in case of difficult climatic conditions.

## COLORI COLOURS

Coperchio Esterno  
External cover

- Bianco / White
- Acciaio INOX / Stainless steel

Calotte  
Flash covers

- Arancio / Orange
- Fumè / Smoke grey

## PERSONALIZZAZIONI CUSTOMIZATIONS

Adesivi (min. 200 pz.)  
Serigrafie (min. 50 pz.)  
Decalco (min. 50 pz.)  
Embossed stickers (200 pcs. min.)  
Serigraphies (50 pcs. min.)  
Decal (50 pcs. min.)



	ECO 700	ECO 700 LS	ECO 700 X	ECO 700 LSX
Alimentazione / Power supply: <b>13.8 Vdc</b>	•	•	•	•
Assorbimento MAX dalla centrale MAX consumption from alarm control panel: <b>600 mA</b>	•	•	•	•
Assorbimento a riposo / Standby consumption: <b>15 mA</b>	•	•	•	•
Assorbimento in allarme dalla batteria Battery consumption in alarm: <b>1.4 A</b>	•	•	•	•
Assorbimento LED / LED consumption: <b>100 mA</b>	•	•	•	•
Frequenza fondamentale / Fundamental frequency: <b>1475 Hz</b>	•	•	•	•
Potenza sonora MAX a 1 m / Sound level MAX at 1 m: <b>dB</b>	110.2	106	110.2	106
Memoria allarme / Alarm memory	•	•	•	•
Possibilità di comando a 3 o 2 fili 3 or 2 wires control option	•	•	•	•
Limite allarmi giornalieri / allarmi infiniti (settabili da dip switch) MAX daily / infinite alarms (settable by dip switch)	•	•	•	•
Test sirena e batteria comandabile da remoto Remote control of sounder and battery test	•	•	•	•
Uscita anomalia / Anomaly output	•	•	•	•
LED interno per individuazione anomalia (su circuito sirena) Anomaly signaling LED (on sounder board)	•	•	•	•
Sistema antiapertura e antirimozione a doppio tamper Anti-opening and anti-removal double-tamper system	•	•	•	•
Sistema antischiuma e antishock brevettato a doppia rilevazione Patented double-detection anti-foam and anti-shock device		•		•
Grado di sicurezza / Security level	3	3	3	3
Classe ambientale / Environmental class: <b>IV</b>	•	•	•	•
Grado protezione / Protection level: <b>IP 44</b>	•	•	•	•
Temperatura di funzionamento / Operating temperature: <b>-25°C ÷ +55°C</b>	•	•	•	•
Resistenza all'impatto / Impact resistance: <b>IK 08</b>	•	•	•	•
Batteria / Battery: <b>12 V 2.1 Ah Pb o/or 12 V 1.2 Ah Pb</b>	•	•	•	•
Conformità alla Normativa <b>EN 50131-4</b> Complying with <b>EN 50131-4</b> Standard	•	•	•	•
 Marchio / Marks: <b>INCERT</b>	•	•	•	•
Peso (gr.) / Weight (gr.)	3040	3020	3000	2970
Pezzi a confezione / Pieces per pack	5	5	5	5

EN 50131-4





# ECO 600

by **SYLCO**  
The sound of security  
by Venitem Group

Sirena d'allarme da esterno con solida struttura in metallo e coperchio in ABS. ECO 600 presenta un design originale e performance garantite.

ECO 600 is an outdoor alarm siren featuring a solid metal structure and external cover in ABS. ECO 600 is aimed at offering original design and high-quality performance.

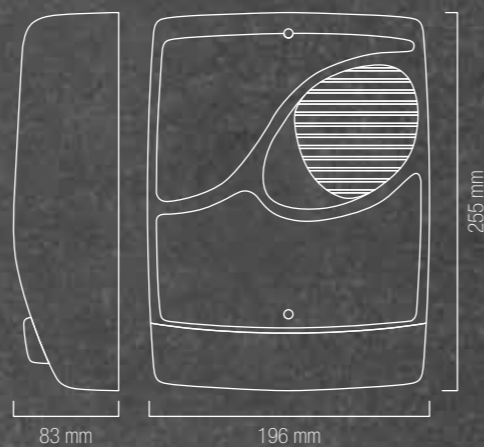

## COLORI COLOURS

### Coperchio Esterno External cover

- ABS Bianco / White ABS
- Bianco (ABS verniciato) / White (painted ABS)  
Colore disponibile con supplemento  
Colour available at extra cost
- Grigio (ABS verniciato) / Grey (painted ABS)  
Colore disponibile con supplemento  
Colour available at extra cost

### Calotte Flash covers

- Arancio / Orange
- Fumè / Smoke grey

## PERSONALIZZAZIONI CUSTOMIZATIONS

Adesivi (min. 200 pz.)  
Serigrafie (min. 50 pz.)  
Decalco (min. 50 pz.)  
Embossed stickers  
(200 pcs. min.)  
Serigraphies (50 pcs. min.)  
Decal (50 pcs. min.)

Supplemento per verniciatura sul  
coperchio in ABS (colori disponibili:  
bianco e grigio).  
Extra cost for ABS external cover painting  
(available colours: white and grey)



	ECO 600	ECO 600 LS
Alimentazione / Power supply: <b>13.8 Vdc</b>	•	•
Assorbimento MAX dalla centrale MAX consumption from alarm control panel: <b>1 A</b>	•	•
Assorbimento a riposo / Standby consumption: <b>15 mA</b>	•	•
Assorbimento in allarme dalla batteria Battery consumption in alarm: <b>1.4 A</b>	•	•
Assorbimento LED / LED consumption: <b>80 mA</b>	•	•
Frequenza fondamentale / Fundamental frequency: <b>1475 Hz</b>	•	•
Potenza sonora MAX a 1 m / Sound level MAX at 1 m: <b>dB</b>	110	110
Memoria allarme / Alarm memory	•	•
Possibilità di comando a 3 o 2 fili 3 or 2 wires control option	•	•
Uscita anomalia / Anomaly output	•	•
LED interno per individuazione anomalia (su circuito sirena) Anomaly signaling LED (on sounder board)	•	•
Sistema antiapertura e antirimozione a doppio tamper Anti-opening and anti-removal double-tamper system	•	•
Sistema antischiuma e antishock brevettato a doppia rilevazione Patented double-detection anti-foam and anti-shock device		•
Grado di sicurezza / Security level	2	2
Classe ambientale / Environmental class: <b>IV</b>	•	•
Grado protezione / Protection level: <b>IP 44</b>	•	•
Temperatura di funzionamento / Operating temperature: <b>-25°C ÷ +55°C</b>	•	•
Resistenza all'impatto / Impact resistance: <b>IK 07</b>	•	•
Batteria / Battery: <b>12 V 2.1 Ah Pb o/or 12 V 1.2 Ah Pb</b>	•	•
Conformità alla Normativa <b>EN 50131-4</b> Complying with <b>EN 50131-4</b> Standard	•	•
Marchio / Marks: <b>INCERT</b>	•	•
Peso (gr.) / Weight (gr.)	2300	2270
Pezzi a confezione / Pieces per pack	5	5



# ECO 560

by **SYLCO**  
the sound of security  
by Venitem Group

ECO 560 è un dispositivo d'allarme solido e versatile, capace di garantire ampie funzionalità e semplicità di installazione.

ECO 560 is a solid and versatile alarm device, able to grant functionality and a simple installation.

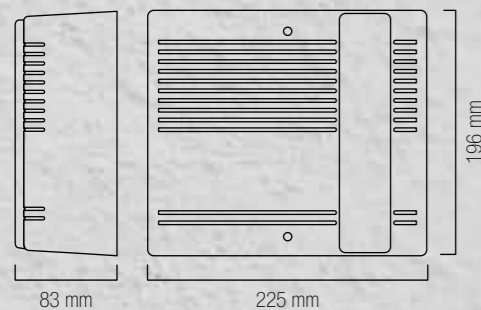

## COLORI COLOURS

### Coperchio Esterno External cover

- ABS Bianco / White ABS
- Bianco (ABS verniciato) / White (painted ABS)  
Colore disponibile con supplemento  
Colour available at extra cost
- Grigio (ABS verniciato) / Grey (painted ABS)  
Colore disponibile con supplemento  
Colour available at extra cost

### Calotte Flash covers

- Arancio / Orange
- Fumè / Smoke grey

## PERSONALIZZAZIONI CUSTOMIZATIONS

- Adesivi (min. 200 pz.)
- Serigrafie (min. 50 pz.)
- Decalco (min. 50 pz.)
- Embossed stickers  
(200 pcs. min.)
- Serigraphies (50 pcs. min.)
- Decal (50 pcs. min.)

Supplemento per verniciatura sul coperchio in ABS (colori disponibili: bianco e grigio).

Extra cost for ABS external cover painting (available colours: white and grey)



	ECO 560	ECO 560 LS
Alimentazione / Power supply: <b>13.8 Vdc</b>	•	•
Assorbimento MAX dalla centrale Max consumption from alarm control panel: <b>500 mA</b>	•	•
Assorbimento a riposo / Standby consumption: <b>15 mA</b>	•	•
Assorbimento in allarme dalla batteria Battery consumption in alarm: <b>1.3 A</b>	•	•
Assorbimento LED / LED consumption: <b>90 mA</b>	•	•
Frequenza fondamentale / Fundamental frequency: <b>1475 Hz</b>	•	•
Potenza sonora MAX a 1 m / Sound level MAX at 1 m: <b>dB</b>	<b>106</b>	<b>106</b>
Memoria allarme / Alarm memory	•	•
Possibilità di comando a 3 o 2 fili 3 or 2 wires control option	•	•
Limite allarmi giornalieri / allarmi infiniti (settabili da dip switch) MAX daily / infinite alarms (settable by dip switch)	•	•
Test sirena e batteria comandabile da remoto Remote control of sounder and battery test	•	•
Uscita anomalia / Anomaly output	•	•
LED interno per individuazione anomalia (su circuito sirena) Anomaly signaling LED (on sounder board)	•	•
Sistema antiapertura e antirimozione a doppio tamper Anti-opening and anti-removal double-tamper system	•	•
Sistema antischiama e antishock brevettato a doppia rilevazione Patented double-detection anti-foam and anti-shock device		•
Grado di sicurezza / Security level	<b>3</b>	<b>3</b>
Classe ambientale / Environmental class: <b>IV</b>	•	•
Grado protezione / Protection level: <b>IP 44</b>	•	•
Temperatura di funzionamento / Operating temperature: <b>-25°C ÷ +55°C</b>	•	•
Resistenza all'impatto / Impact resistance: <b>IK 08</b>	•	•
Batteria / Battery: <b>12 V 2.1 Ah Pb o/or 12 V 1.2 Ah Pb</b>	•	•
Conformità alla Normativa <b>EN 50131-4</b> Complying with <b>EN 50131-4</b> Standard	•	•
Marchio / Marks: <b>INCERT</b>	•	•
Peso (gr.) / Weight (gr.)	2050	2290
Pezzi a confezione / Pieces per pack	5	5

ECO 500 è una sirena dalle linee classiche e dalla tecnologia impeccabile, disponibile in diversi modelli e materiali per soddisfare al meglio qualsiasi esigenza di sicurezza.

ECO 500 is an outdoor sounder boasting classic design and unfailable technology. This sounder range is available in different models and materials to best satisfy any security needs.

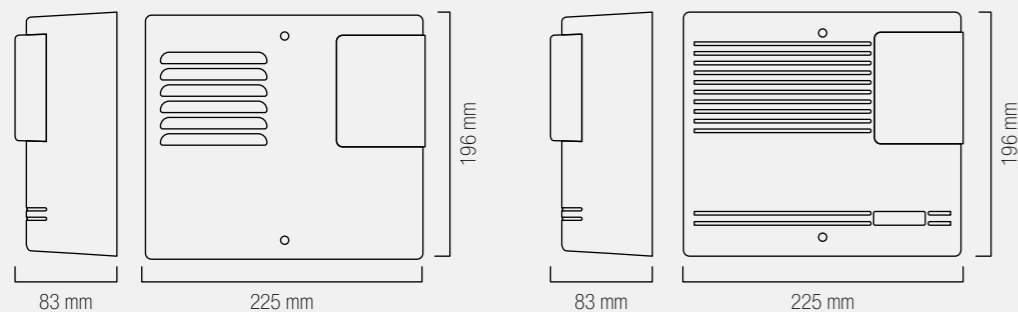
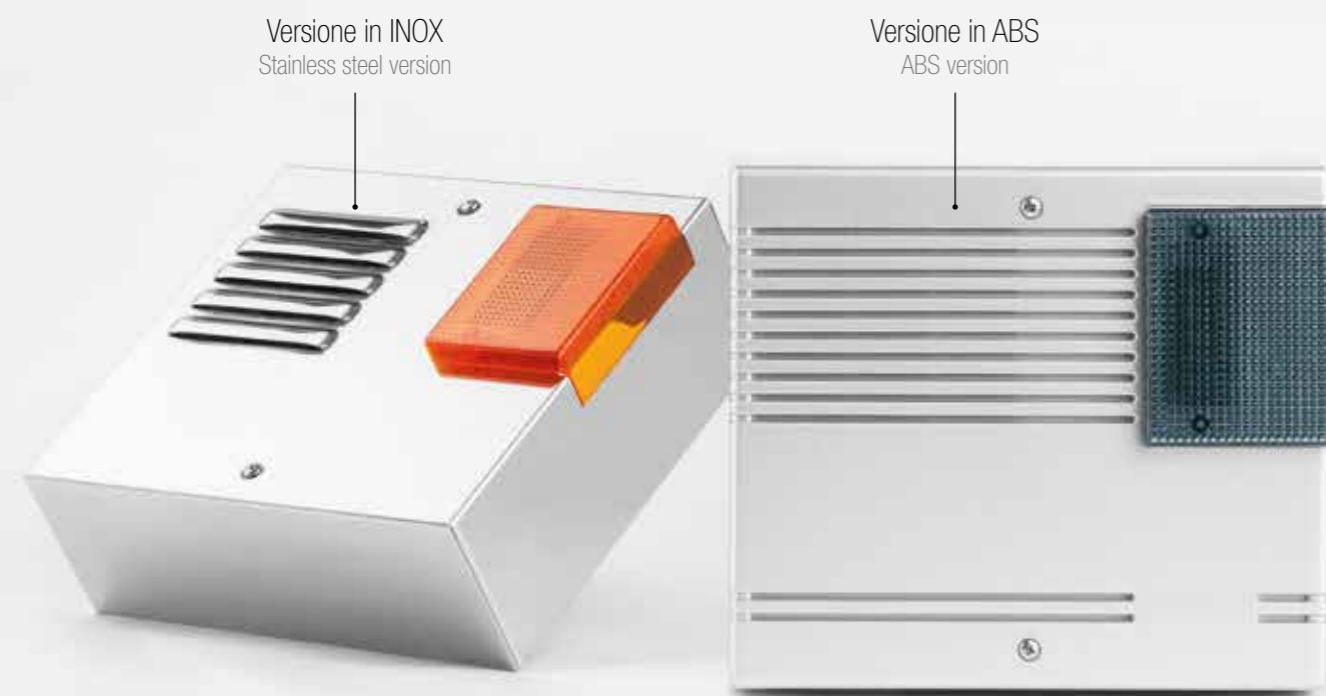

## COLORI COLOURS

### Coperchio Esterno External cover

- ABS Bianco / White ABS
- Bianco (ABS verniciato) / White (painted ABS)  
Colore disponibile con supplemento  
Colour available at extra cost
- Grigio (ABS verniciato) / Grey (painted ABS)  
Colore disponibile con supplemento  
Colour available at extra cost
- Acciaio INOX / Stainless steel

### Calotte Flash covers

- Arancio / Orange
- Fumè / Smoke grey

## PERSONALIZZAZIONI CUSTOMIZATIONS









- Adesivi (min. 200 pz.)
- Serigrafie (min. 50 pz.)
- Decalco (min. 50 pz.)
- Embossed stickers (200 pcs. min.)
- Serigraphies (50 pcs. min.)
- Decal (50 pcs. min.)

Supplemento per verniciatura sul coperchio in ABS (colori disponibili: bianco e grigio).

Extra cost for ABS external cover painting (available colours: white and grey)

	ECO 500	ECO 500 LS	ECO 500 X	ECO 500 LSX
Alimentazione / Power supply: <b>13.8 Vdc</b>	•	•	•	•
Assorbimento MAX dalla centrale MAX consumption from alarm control panel: <b>500 mA</b>	•	•	•	•
Assorbimento a riposo / Standby consumption: <b>15 mA</b>	•	•	•	•
Assorbimento in allarme dalla batteria Battery consumption in alarm: <b>1.3 A</b>	•	•	•	•
Assorbimento LED / LED consumption: <b>90 mA</b>	•	•	•	•
Frequenza fondamentale / Fundamental frequency: <b>1475 Hz</b>	•	•	•	•
Potenza sonora MAX a 1 m / Sound level MAX at 1 m: <b>dB</b>	106	106	106	106
Memoria allarme / Alarm memory	•	•	•	•
Possibilità di comando a 3 o 2 fili 3 or 2 wires control option	•	•	•	•
Limite allarmi giornalieri / allarmi infiniti (settabili da dip switch) MAX daily / infinite alarms (settable by dip switch)	•	•	•	•
Test sirena e batteria comandabile da remoto Remote control of sounder and battery test	•	•	•	•
Uscita anomalia / Anomaly output	•	•	•	•
LED interno per individuazione anomalia (su circuito sirena) Anomaly signaling LED (on sounder board)	•	•	•	•
Sistema antiapertura e antirimozione a doppio tamper Anti-opening and anti-removal double-tamper system	•	•	•	•
Sistema antischiuma e antishock brevettato a doppia rilevazione Patented double-detection anti-foam and anti-shock device		•		•
Grado di sicurezza / Security level	3	3	3	3
Classe ambientale / Environmental class: <b>IV</b>	•	•	•	•
Grado protezione / Protection level: <b>IP 44</b>	•	•	•	•
Temperatura di funzionamento / Operating temperature: <b>-25°C ÷ +55°C</b>	•	•	•	•
Resistenza all'impatto / Impact resistance: <b>IK 08</b>	•	•	•	•
Batteria / Battery: <b>12 V 2.1 Ah Pb o/or 12 V 1.2 Ah Pb</b>	•	•	•	•
Conformità alla Normativa <b>EN 50131-4</b> Complying with <b>EN 50131-4</b> Standard	•	•	•	•
Marchio / Marks: <b>INCERT</b>	•	•	•	•
Peso (gr.) / Weight (gr.)	2030	2020	2540	2520
Pezzi a confezione / Pieces per pack	5	5	5	5

SIRENE ANTIFURTO DA INTERNO  
INTRUSION INDOOR ALARM SOUNDERS

	MINI HOLA	MINI DOGE	MINI MURANO	SP200	GHOST	LAGUNA	SP303T	SP302T
 Autoalimentazione Self-powering	•	•	•			•		
 Lampeggiante a LED LED flashing unit	•	•	•	•				
 LED blu per segnalazione ON/OFF impianto e funzione di LUCE DI CORTESIA Blue LED for system ON/OFF signaling and COURTESY-LIGHT function	•	•	•					
 Scheda audio con suono di alta potenza High-power volume sound card	•	•				•		
 Numero suoni Sounds number	8	8	3	2	1	2	4	4
 Numero temporizzazioni Timings number	2	2	1			2		
 Tamper antiapertura e antirimozione Anti-opening and anti-removal tamper	•	•	•	•		•		
 Materiale Material	P	P	P	P	P	M	P	P

• = NOVITÀ / NEW  
TM = micro switch

P = plastica ABS / ABS plastic  
M = metallo verniciato / painted metal



# MINI HOLA

Design ricercato e tecnologia innovativa per la protezione dei propri spazi. Mini Hola è una sirena d'allarme "intelligente" che consente un'immediata localizzazione dell'allarme e una protezione totale.

Refined design and innovative technology to protect your spaces. Mini Hola is a smart sounder allowing immediate localization of the alarm and total protection.

## DI SERIE

### STANDARD FEATURES

Suono di ALTA POTENZA regolabile  
HIGH-POWER adjustable sound

8 suoni programmabili per allarme ed evacuazione  
8 programmable sounds for alarm and evacuation

LED BLU per segnalazione ON/OFF impianto e  
funzione di LUCE DI CORTESIA  
BLUE LED for system ON/OFF signaling and COURTESY-LIGHT  
function

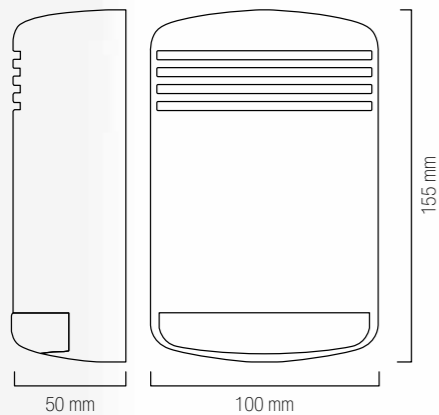



Nuovo LED BLU con funzione di luce di cortesia  
New BLUE LED for courtesy-light function

## COLORI COLOURS

Coperchio Esterno  
External cover

- Bianco / White
- Bianco opaco / Matt white  
Colore disponibile con supplemento  
Colour available at extra cost
- Grigio opaco / Matt grey  
Colore disponibile con supplemento  
Colour available at extra cost

Calotte  
Flash covers

- Arancio / Orange
- Azzurro / Light blue

## PERSONALIZZAZIONI CUSTOMIZATIONS

Supplemento per colori bianco opaco e grigio opaco  
Extra cost for matt white and matt grey colours

Supplemento per colorazioni personalizzate (min. 50 pz.)

Costi di realizzazione da calcolare a parte

Extra cost for customized colours (50 pcs. min.)

Costs calculated separately

## RICAMBI ACCESSORY

Calotta per lampeggiante in policarbonato

Colori disponibili: arancio e azzurro



Polycarbonate cover for flashing device

Available colours: orange and light blue

Pacchetto batterie 8,4 Vdc 800 mA Ni-MH

Battery: 8.4 Vdc 800 mA Ni-MH



	MINI HOLA	MINI HOLA L	MINI HOLA A	MINI HOLA AL
Alimentazione / Power supply: <b>13.8 Vdc</b>	•	•	•	•
Autoalimentata / Self-supplied			•	•
Assorbimento MAX in allarme (mA) MAX consumption during alarm (mA)	160	170	160	170
Assorbimento MAX in preallarme (mA) MAX consumption during alarm (mA)	70	80	70	80
Assorbimento LED / LED consumption: <b>12 mA</b>		•		•
Assorbimento MAX di ricarica MAX consumption during recharge: <b>40 mA</b>			•	•
Potenza sonora MAX a 1 m / Sound level MAX at 1 m: <b>dB</b>	96.3	96.3	100.6	100.6
Suoni allarme / preallarme / evacuazione Alarm / pre-alarm / evacuation sounds	8	8	8	8
Assorbimento e potenza regolabili Adjustable consumption and power	•	•	•	•
Scheda audio con suono ad alta potenza High-power volume sound card	•	•	•	•
LED blu per luce di cortesia e segnalazione ON/OFF Blue LED for courtesy-light and ON/OFF signaling		•		•
Sistema antiapertura e antirimozione a doppio tamper Anti-opening and anti-removal double-tamper system	•	•	•	•
Grado di sicurezza / Security level	3	3	3	3
Classe ambientale / Environmental class: <b>II</b>	•	•	•	•
Grado protezione / Protection level: <b>IP 4X</b>	•	•	•	•
Temperatura di funzionamento / Operating temperature: <b>-25°C ÷ +50°C</b>	•	•	•	•
Resistenza all'impatto / Impact resistance: <b>IK 07</b>	•	•	•	•
Batteria / Battery: <b>8,4 Vdc 800 mA Ni-MH</b>			•	•
Certificazione di Conformità alla Normativa <b>EN 50131-4</b> Complying with <b>EN 50131-4</b> Standard	•	•	•	•
 Marchio / Marks: <b>IMQ Sistemi di sicurezza</b>	•	•	•	•
 Marchio / Marks: <b>INCERT</b>	•	•	•	•
Peso (gr.) / Weight (gr.)	171	176	264	262
Pezzi a confezione / Pieces per pack	20	20	20	20



# MINI MURANO

Mini Murano è la sirena da interno dal design originale creata per fungere da complemento di arredo oltre che da infallibile strumento di sicurezza.

Mini Murano indoor sounder's original design makes it the perfect furniture complement as well as an excellent security device.

## DI SERIE STANDARD FEATURES

Suono di ALTA POTENZA regolabile / HIGH-POWER adjustable sound

Suoni programmabili per allarme ed evacuazione / Programmable sounds for alarm and evacuation

LED BLU per segnalazione ON/OFF impianto e funzione di LUCE DI CORTESIA  
BLUE LED for system ON/OFF signaling and COURTESY-LIGHT function

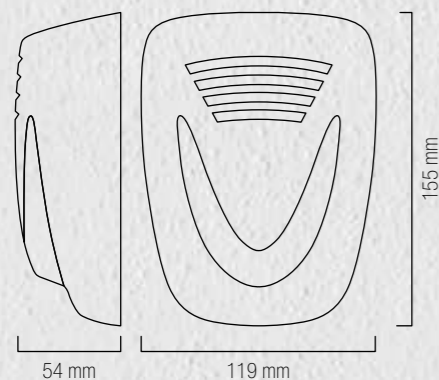



Nuovo LED BLU con funzione di luce di cortesia  
New BLUE LED for courtesy-light function

## COLORI COLOURS

Coperchio Esterno  
External cover

- Bianco / White
- Bianco perlato / Pearly white  
Colore disponibile con supplemento  
Colour available at extra cost
- Grigio argentato / Silver grey  
Colore disponibile con supplemento  
Colour available at extra cost

Calotte  
Flash covers

- Arancio / Orange
- Fumè / Smoke grey

## PERSONALIZZAZIONI CUSTOMIZATIONS

Supplemento per colori bianco perlato e grigio argentato  
Extra cost for pearly white and silver grey colours



Supplemento per colorazioni personalizzate (min. 50 pz.)  
Costi di realizzazione da calcolare a parte  
Extra cost for customized colours (50 pcs. min.)  
Costs calculated separately

## RICAMBI ACCESSORY

Calotta per lampeggiante in policarbonato  
Colori disponibili: arancio e fumè  
Polycarbonate cover for flashing device  
Available colours: orange and smoke grey

Pacchetto batterie 8,4 Vdc 170 mA Ni-MH  
Battery: 8.4 Vdc 170 mA Ni-MH



	MINI MURANO	MINI MURANO L	MINI MURANO A	MINI MURANO AL
Alimentazione / Power supply: <b>13.8 Vdc</b>	•	•	•	•
Autoalimentata / Self-supplied			•	•
Assorbimento MAX in allarme MAX consumption during alarm: <b>130 mA</b>	•	•	•	•
Assorbimento in preallarme (mA) Consumption during pre-alarm (mA)	25	50	40	60
Assorbimento LED / LED consumption: <b>10 mA</b>		•		•
Assorbimento MAX di ricarica MAX consumption during recharge: <b>20 mA</b>			•	•
Potenza sonora MAX a 1 m / Sound level MAX at 1 m: <b>dB</b>	98	98	96.7	96.7
Attenuazione preallarme / Pre-alarm attenuation: <b>-10 dB</b>	•	•	•	•
Suoni allarme / Alarm sounds	2	2	3	3
Suoni preallarme / Pre-alarm sounds	2	2	3	3
LED blu per luce di cortesia e segnalazione ON/OFF Blue LED for courtesy-light and ON/OFF signaling		•		•
Sistema antiapertura e antirimozione a doppio tamper Anti-opening and anti-removal double-tamper system	•	•	•	•
Grado di sicurezza / Security level	3	3	2	2
Classe ambientale / Environmental class: <b>II</b>	•	•	•	•
Grado protezione / Protection level: <b>IP 4X</b>	•	•	•	•
Temperatura di funzionamento / Operating temperature: <b>-25°C ÷ +50°C</b>	•	•	•	•
Resistenza all'impatto / Impact resistance: <b>IK 07</b>				
Batteria / Battery: <b>8,4 Vdc 170 mA Ni-MH</b>			•	•
Certificazione di Conformità alla Normativa <b>EN 50131-4</b> Complying with <b>EN 50131-4</b> Standard	•	•	•	•
 Marchio / Marks: <b>IMQ Sistemi di sicurezza</b>	•	•	•	•
 Marchio / Marks: <b>INCERT</b>	•	•	•	•
Peso (gr.) / Weight (gr.)	170	172	203	204
Pezzi a confezione / Pieces per pack	20	20	20	20



## MINI DOGE

Design elegante e raffinato. Una vasta gamma cromatica per una sirena d'allarme di alta tecnologia capace di assicurare una totale protezione conferendo stile e carattere a tutti i tipi di ambiente.

Elegant and refined design, a wide chromatic range for a high-technology alarm sounder. MINI DOGE assures total protection and lends style and character to all spaces.

### DI SERIE STANDARD FEATURES

Suono di ALTA POTENZA regolabile  
HIGH-POWER adjustable sound

8 suoni programmabili per allarme ed evacuazione  
8 programmable sounds for alarm and evacuation

LED BLU per segnalazione ON/OFF impianto e  
funzione di LUCE DI CORTESIA  
BLUE LED for system ON/OFF signaling and COURTESY-LIGHT  
function

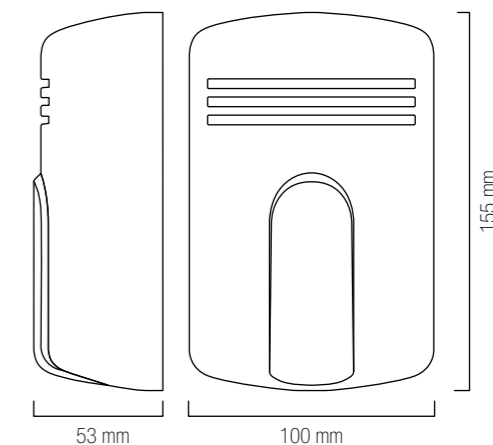

## COLORI COLOURS

### Coperchio Esterno External cover

- Bianco / White
- Champagne / Champagne  
Colore disponibile con supplemento  
Colour available at extra cost
- Acciaio / Grey  
Colore disponibile con supplemento  
Colour available at extra cost
- Rame / Copper  
Colore disponibile con supplemento  
Colour available at extra cost

### Calotte Flash covers

- Arancio / Orange
- Fumè / Smoke grey



Nuovo LED BLU con funzione di luce di cortesia  
New BLUE LED for courtesy-light function

## PERSONALIZZAZIONI CUSTOMIZATIONS

Supplemento per colori champagne, acciaio e rame  
Extra cost for champagne, grey and copper colours



Supplemento per colorazioni personalizzate (min. 50 pz.)  
Costi di realizzazione da calcolare a parte  
Extra cost for customized colours (50 pcs. min.)  
Costs calculated separately

## RICAMBI ACCESSORY

Calotta per lampeggiante in policarbonato  
Colori disponibili: arancio e fumè  
Polycarbonate cover for flashing device  
Available colours: orange and smoke grey

Pacchetto batterie 8,4 Vdc 800 mA Ni-MH  
Battery: 8.4 Vdc 800 mA Ni-MH



	MINI DOGE	MINI DOGE L	MINI DOGE A	MINI DOGE AL
Alimentazione / Power supply: <b>13.8 Vdc</b>	•	•	•	•
Autoalimentata / Self-supplied			•	•
Assorbimento MAX in allarme (mA) MAX consumption during alarm (mA)	160	170	160	170
Assorbimento MAX in preallarme (mA) MAX consumption during alarm (mA)	70	80	70	80
Assorbimento LED / LED consumption: <b>12 mA</b>		•		•
Assorbimento MAX di ricarica MAX consumption during recharge: <b>40 mA</b>			•	•
Potenza sonora MAX a 1 m / Sound level MAX at 1 m: <b>dB</b>	96.3	96.3	100.6	100.6
Suoni allarme / preallarme / evacuazione Alarm / pre-alarm / evacuation sounds	8	8	8	8
Assorbimento e potenza regolabili Adjustable consumption and power	•	•	•	•
Scheda audio con suono ad alta potenza High-power volume sound card	•	•	•	•
LED blu per luce di cortesia e segnalazione ON/OFF Blue LED for courtesy-light and ON/OFF signaling		•		•
Sistema antiapertura e antirimozione a doppio tamper Anti-opening and anti-removal double-tamper system	•	•	•	•
Grado di sicurezza / Security level	3	3	3	3
Classe ambientale / Environmental class: <b>II</b>	•	•	•	•
Grado protezione / Protection level: <b>IP 4X</b>	•	•	•	•
Temperatura di funzionamento / Operating temperature: <b>-25°C ÷ +50°C</b>	•	•	•	•
Resistenza all'impatto / Impact resistance: <b>IK 07</b>	•	•	•	•
Batteria / Battery: <b>8,4 Vdc 800 mA Ni-MH</b>			•	•
Certificazione di Conformità alla Normativa <b>EN 50131-4</b> Complying with <b>EN 50131-4</b> Standard	•	•	•	•
 Marchio / Marks: <b>IMQ Sistemi di sicurezza</b>	•	•	•	•
 Marchio / Marks: <b>INCERT</b>	•	•	•	•
Peso (gr.) / Weight (gr.)	236	241	325	328
Pezzi a confezione / Pieces per pack	20	20	20	20



	SP200	SP200L
Alimentazione / Power supply: <b>13.8 Vdc</b>	•	•
Assorbimento in allarme (mA) Consumption during alarm (mA)	100	120
Assorbimento in preallarme (mA) Consumption during pre-alarm (mA)	25	37
Assorbimento LED (mA) / LED consumption (mA)		20
Potenza sonora in allarme (dB) (A) a 1 m Sound level during alarm (dB) (A) at 1 m	104	104
Potenza sonora MAX a 1 m / Sound level MAX at 1 m: <b>dB</b>	91	81
Suoni allarme / Alarm sounds	1	1
Suoni preallarme / Pre-alarm sounds	1	1
Sistema antiapertura e antirimozione a doppio tamper Anti-opening and anti-removal double-tamper system	•	•
Classe ambientale / Environmental class: <b>II</b>	•	•
Grado protezione / Protection level: <b>IP 3X</b>	•	•
Temperatura di funzionamento / Operating temperature: <b>-25°C ÷ +50°C</b>	•	•
Peso (gr.) / Weight (gr.)	153	151
Pezzi a confezione / Pieces per pack	20	20

## SP200

SP200 è una sirena studiata per risultare adatta a qualsiasi tipo di ambiente interno. Il suo design molto gradevole e lineare, la rende un elemento essenziale ma allo stesso tempo altamente funzionale ai fini della sicurezza.

SP200 is a sounder conceived to offer easy fitting to any kind of indoor application. Its nice and simple design makes it an essential and at the same time highly-functional protection accessory.

### COLORI COLOURS

- Coperchio Esterno  
External cover
- Bianco / White
- Calotte  
Flash covers
- Arancio / Orange

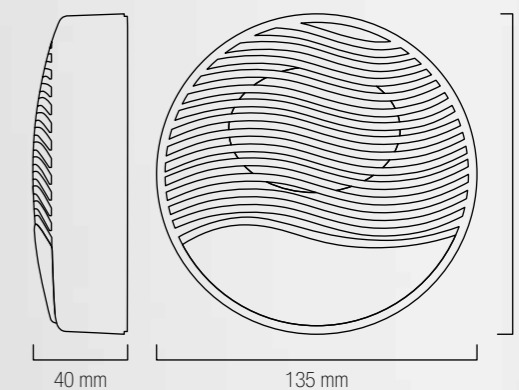



GHOST / Q

Alimentazione / Power supply: <b>12.5 Vdc</b>	•
Massimo assorbimento / MAX consumption: <b>40 mA</b>	•
Potenza sonora a 1 m / Sound level at 1 m: <b>105 dB (A)</b>	•
Grado protezione / Protection level: <b>IP 40</b>	•
Temperatura di funzionamento / Operating temperature: <b>+5°C +40°C</b>	•
Dimensione foro (mm) / Hole size (mm)	Ø 57± 0.5
Peso (gr.) / Weight (gr.)	56
Pezzi / Pieces	5

-  **ALTO LIVELLO SONORO**  
HIGH SOUND LEVEL
-  **MAX RISPARMIO ENERGETICO**  
MAX ENERGY SAVING
-  **SISTEMA DI MONTAGGIO RAPIDO**  
QUICK MOUNTING SYSTEM

# GHOST

GHOST è una sirena per interni ad incasso dal design innovativo e dalle dimensioni estremamente ridotte, adatta per l'installazione su controsoffittature, pannelli metallici o plastici. L'installazione a pressione, semplice e veloce, evita l'impiego di viti o tasselli. GHOST è disponibile anche in versione quadrata.

GHOST is a new indoor sounder suitable for flush mounting in false ceilings, metal and plastic panels. Smart design, high performance, very low consumption and a clip-in mounting system with no screws. GHOST is also available in square version.

## COLORI COLOURS

Coperchio Esterno  Bianco / White  
External cover

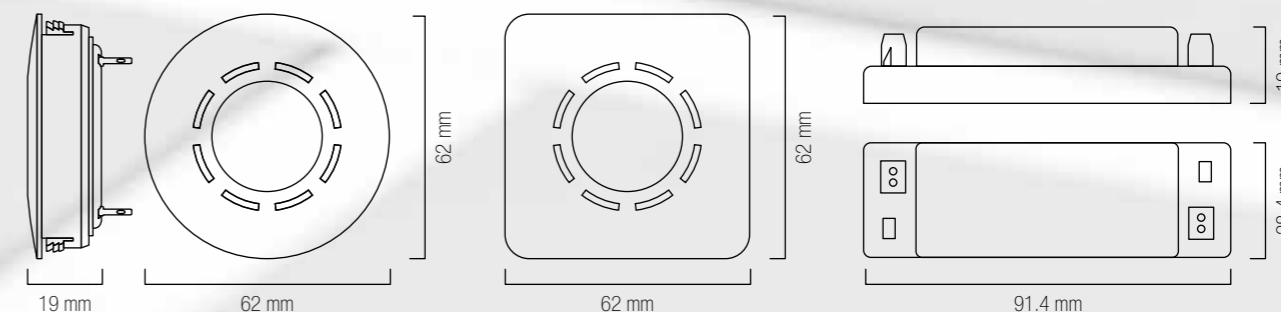





# LAGUNA

Sirena da interno studiata per la protezione dei grandi ambienti o degli spazi industriali, ove sia presente un forte rumore di fondo. Attraverso l'utilizzo di un buzzer piezoelettrico, Laguna è utilizzabile anche come segnalatore di preallarme, entrata-uscita o altre segnalazioni.

Laguna is an indoor sounder developed to be installed in industrial environments having high noise level. Through the utilization of a piezoelectric buzzer, this sounder is perfect also to notify pre-alarm, entry/exit events as well as for other notices.

## COLORI COLOURS

Coperchio Esterno  
External cover

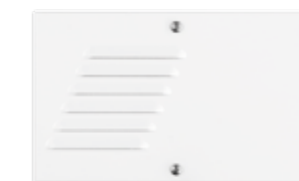

	LAGUNA	LABUNA/B
Alimentazione / Power supply: <b>13.8 Vdc</b>	•	•
Autoalimentata / Self-supplied	•	•
Potenza sonora in allarme (A) a 1 m Sound level during alarm (A) at 1 m: <b>117 dB</b>	•	•
Suoni allarme / Alarm sounds	2	2
Buzzer per preallarme Buzzer for pre-alarm signaling		•
Sistema antiapertura e antirimozione a doppio tamper Anti-opening and anti-removal double-tamper system	•	•
Classe ambientale / Environmental class: <b>II</b>	•	•
Grado protezione / Protection level: <b>IP 4X</b>	•	•
Temperatura di funzionamento / Operating temperature: <b>-25°C ÷ +50°C</b>	•	•
Batteria / Battery: <b>1.2 Ah</b>	•	•
Peso (gr.) / Weight (gr.)	1299	1318
Pezzi a confezione / Pieces per pack	20	20

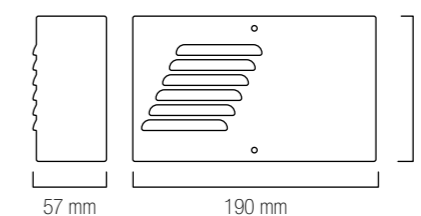

# SP 303T

by **SYLCO**  
the sound of security  
by Veritem Group

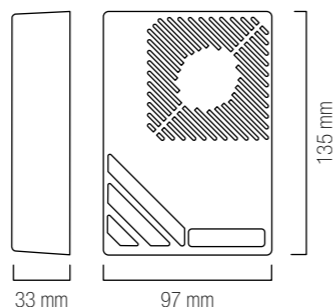

Coperchio Esterno External cover  Bianco / White

Una sirena studiata per assicurare una completa protezione dei vostri ambienti. Il suo design discreto e lineare, unito alle alte performance, la rendono un affidabile elemento di sicurezza.

SP 303T is a siren studied to ensure complete protection. Its smart linear design and high performances make it an excellent element of security.

Alimentazione / Power supply	13.8 Vdc
Autoalimentata / Self-supplied:	MIN 20 mA MAX 110 mA
Potenza sonora in allarme (dB) (A) a 1 m Sound level during alarm (dB) (A) at 1 m	110 dB MAX
Suoni allarme / Alarm sounds	4
Sistema antiapertura e antirimozione a doppio tamper Anti-opening and anti-removal double-tamper system	•
Grado di sicurezza / Security level	2
Classe ambientale / Environmental class	II
Grado protezione / Protection level	IP31
Temperatura di funzionamento / Operating temperature: -25°C ÷ +50°C	•
Resistenza all'impatto / Impact resistance	IK 06
Conformità alla Normativa EN 50131-4 Complying with EN 50131-4 Standard	•
 Marchio / Marks: <b>INCERT</b>	•
Peso (gr.) / Weight (gr.)	148
Pezzi a confezione / Pieces per pack	30

# SP 203T

by **SYLCO**  
the sound of security  
by Veritem Group

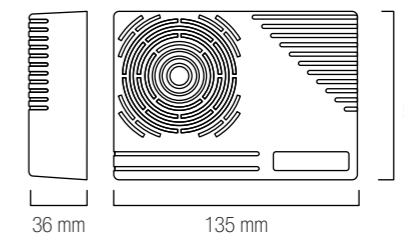

Coperchio Esterno External cover  Bianco / White

SP 203T è una sirena d'allarme da interno caratterizzata da un design essenziale e un'estrema efficienza tecnica, che la rendono un prodotto di sicurezza valido e versatile; un'ottima alternativa per chi abbia l'esigenza di un prodotto adatto al montaggio orizzontale.

SP 203T is an indoor alarm siren characterized by an essential design and an efficient technology that makes it a very valid and versatile siren: the perfect solution in case of horizontal installations.

Alimentazione / Power supply	13.8 Vdc
Autoalimentata / Self-supplied:	MIN 20 mA MAX 110 mA
Potenza sonora in allarme (dB) (A) a 1 m Sound level during alarm (dB) (A) at 1 m	110 dB MAX
Suoni allarme / Alarm sounds	4
Sistema antiapertura e antirimozione a doppio tamper Anti-opening and anti-removal double-tamper system	•
Grado di sicurezza / Security level	2
Classe ambientale / Environmental class	II
Grado protezione / Protection level	IP31
Temperatura di funzionamento / Operating temperature: -25°C ÷ +50°C	•
Resistenza all'impatto / Impact resistance	IK 06
Conformità alla Normativa EN 50131-4 Complying with EN 50131-4 Standard	•
 Marchio / Marks: <b>INCERT</b>	•
Peso (gr.) / Weight (gr.)	152
Pezzi a confezione / Pieces per pack	30



SIRENE ANTINCENDIO E EVACUAZIONE  
FIRE ALARM AND EVACUATION SOUNDERS

# DOGE F24

Una delle sirene antincendio più avanzate del settore, Doge F24 è costruita a norma di legge e certificata secondo le più recenti normative sui prodotti antincendio.

Doge F24 is one of most innovative fire alarm sounders of the security market, built according to the most recent standard regarding fire alarm products.

## INFORMAZIONI TECNICHE TECHNICAL INFORMATION

Tensione nominale di alimentazione (Vn) Power supply (Vn)	<b>24 Vdc (da 22 Vdc a 28 Vdc)</b> 24 Vdc (from 22 Vdc to 28 Vdc)
Batteria in tampone Buffer battery	<b>12 V - 2.2 Ah Pb</b>
Corrente di ricarica MAX MAX recharge current	<b>0.5A</b>
Potenza sonora MAX MAX sound level	<b>102 dB (A) a 1 m</b> 102 dB (A) at 1 m
Frequenza Frequency	<b>1000 Hz /1700 Hz</b>
Anomalia Anomaly	<b>LED rosso e uscita anomalia</b> Red LED and anomaly output
Grado di protezione Protection level	<b>IP 33C</b>
Temperatura di funzionamento Operating temperature	<b>Da -25 °C a +70°C</b> From -25 °C to +70°C
Tipo B B type	<b>Per ambienti esterni</b> Outdoor sounder
Peso Weight	<b>2094 gr.</b>

Certificata secondo regolamento Europeo n° 305/2011/EU  
(Construction Products Regulation - CPR) e la Norma EN 54-3  
Certified according to European regulation n° 305/2011/UE  
(Construction Products Regulation - CPR) and EN 54-3 Standard

**Coperchio interno in metallo speciale**  
Internal cover in special metal

**Circuiti tropicalizzati in resina ad immersione**  
Circuits protected by resin immersion



**Coperchio esterno in ABS V0 verniciato**  
External cover in painted V0 ABS

**Verniciatura micalizzata**  
Mica painting process

## COLORI COLOURS

Coperchio Esterno External cover	● Rosso brillante / Shiny red
Calotte Flash covers	● Rosso / Red
	● Fumè / Smoke grey

## PERSONALIZZAZIONI CUSTOMIZATIONS

Adesivo resinato "ALLARME INCENDIO" - non incluso  
"FIRE ALARM" embossed sticker - not included

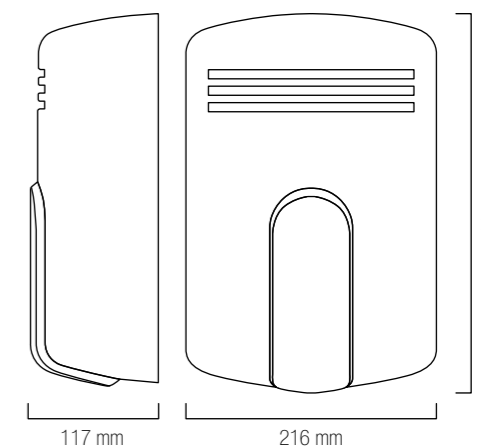

# TRIADE F24

Una sirena solida e funzionale, una tecnologia autentica e consolidata, Triade F24 è costruita a norma di legge capace di soddisfare qualsiasi necessità prestazionale.

A robust and performing sounder, a safe and consolidated technology. Triade F24 is built in respect of the most updated standard thus being able to satisfy any technical needs.

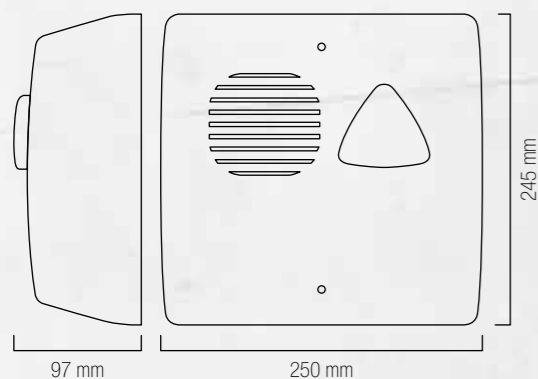

Certificata secondo regolamento Europeo n° 305/2011/EU  
(Construction Products Regulation - CPR) e la Norma EN 54-3  
Certified according to European regulation n° 305/2011/UE  
(Construction Products Regulation - CPR) and EN 54-3 Standard

## COLORI COLOURS

Coperchio Esterno External cover		Rosso brillante / Shiny red
Calotte Flash covers		Rosso / Red
		Fumè / Smoke grey

## PERSONALIZZAZIONI CUSTOMIZATIONS

Adesivo resinato "ALLARME INCENDIO" - non incluso  
"FIRE ALARM" embossed sticker - not included

## INFORMAZIONI TECNICHE TECHNICAL INFORMATION

Tensione nominale di alimentazione (Vn) Power supply (Vn)	<b>24 Vdc (da 22 Vdc a 28 Vdc)</b> 24 Vdc (from 22 Vdc to 28 Vdc)
Batteria in tampone Buffer battery	<b>12 V - 2.2 Ah Pb</b>
Corrente di ricarica MAX MAX recharge current	<b>0.5A</b>
Potenza sonora MAX MAX sound level	<b>103 dB (A) a 1 m</b> 103 dB (A) at 1 m
Frequenza Frequency	<b>1000 Hz /1700 Hz</b>
Anomalia Anomaly	<b>LED rosso e uscita anomalia</b> Red LED and anomaly output
Grado di protezione Protection level	<b>IP 33C</b>
Temperatura di funzionamento Operating temperature	<b>Da -25 °C a +70°C</b> From -25 °C to +70°C
Tipo B B type	<b>Per ambienti esterni</b> Outdoor sounder
Peso Weight	<b>2153 gr.</b>

# MINI DOGE F24 E FL24

Mini Doge F24 e Mini Doge FL24 sono le sirene antincendio per uso interno di Venitem. Nate da un design di alto livello, queste sirene risultano estremamente performanti e adatte a qualsiasi tipo di ambiente.

The fire sounders for indoor use Mini Doge F24 and Mini Doge FL24 have been designed to satisfy in a smart way any need for security and can be installed in any indoor context.

## INFORMAZIONI TECNICHE TECHNICAL INFORMATION

	MINI DOGE F24	MINI DOGE FL24
Alimentazione / Power supply: <b>24 Vdc (da/from 22 Vdc a/to 28 Vdc)</b>	•	•
Assorbimento MAX / MAX consumption	37 mA	60 mA
Potenza sonora a 3 m / Sound level at 3 m: <b>101 dB (A)</b>	•	•
Frequenza a suono continuo / Continuous sound frequency: <b>1800 Hz</b>	•	•
Frequenza a suono intermittente / Intermittent sound frequency: <b>1900 Hz</b>	•	•
Frequenza a suono bitonale / Bitonal sound frequency: <b>2000 Hz / 3500 Hz</b>	•	•
Frequenza a suono tritonale / Tritonal sound frequency: <b>2200 Hz / 1800 Hz / 1500 Hz</b>	•	•
Lampeggiante a LED / LED flashing light		•
Temperatura di funzionamento / Operating temperature: <b>-10 °C +55 °C</b>	•	•
Protezione / Protection level: <b>IP 41C</b>	•	•
Tipo A / A type: <b>per ambienti interni / indoor sounder</b>	•	•
Peso (gr.) / Weight (gr.)	179	180
Certificazione di Conformità / Declaration of standard conformity	0051-CPR-0159	0051-CPR-0159
Normativa di riferimento / Approved: <b>EN 54 - 3</b>	•	•
Ente notificato / Certifying authority: <b>IMQ (0051)</b>	•	•



## COLORI COLOURS

- Coperchio Esterno  
External cover
- Rosso brillante / Shiny red
- Calotte  
Flash covers
- Rosso / Red
  - Fumè / Smoke grey

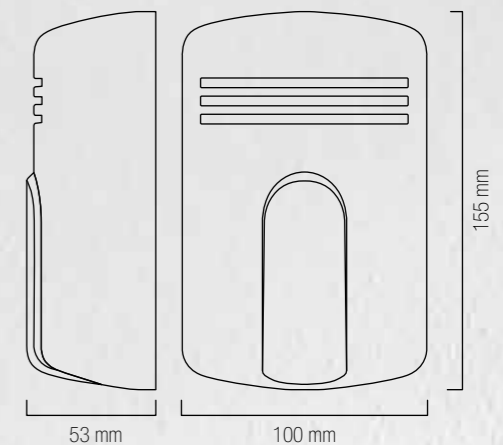

# DOGE EV

Alta tecnologia e infinite soluzioni per la linea evacuazione di Venitem. Differenti modelli da utilizzare a seconda delle necessità, disponibili anche in versione vocale, con messaggi pre-registrati e possibilità di inserire messaggi personalizzati. Tutto racchiuso nell'intramontabile design Doge, che rende un prodotto tecnologicamente avanzato, ancora più raffinato ed elegante.

High-technology and different solutions for Venitem evacuation sounders. Various models to choose according to different needs, available also in vocal version, with pre-recorded messages and the possibility to record free messages. All models are housed in Doge timeless design, that is able to make technologically-advanced products even more refined and attractive.

## PERSONALIZZAZIONI CUSTOMIZATIONS

Adesivo resinato "ALLARME EVACUAZIONE" - non incluso  
"EVACUATION ALARM" embossed sticker - not included

## INFORMAZIONI TECNICHE TECHNICAL INFORMATION

	EV 12	EV 24	EV 230	VOCALE / VOCAL
Alimentazione / Power supply:	13.8 Vdc	24 Vdc	230 Vdc	12 o/or 24 Vdc
Assorbimento MAX / MAX consumption	1.5 A	750 mA	100 mA	1.8 A
Pressione sonora in allarme evacuazione a 3 m Sound level in evacuation alarm at 3 m	100 dB (A)	100 dB (A)	100 dB (A)	100 dB (A)
Pressione sonora allertamento a 3 m / Alert sound level at 3 m	99 dB (A)	99 dB (A)	99 dB (A)	99 dB (A)
Suono allertamento / Alert sound: <b>Intermitt.</b>	•	•	•	
Suono evacuazione 1 / Evacuation sound no.1: <b>Continuo / Bi-tonale - Continuos / Bitonal</b>	•	•	•	Messaggio vocale Vocal message
Suono evacuazione 2 (programmabile da dip-switch) / Evacuation sound no.2 (settable through dip-switch): <b>Continuo o campana / Continuous or bell</b>	•	•	•	
8 messaggi pre-registrati di cui 1 personalizzabile (registrabile solo da fabbrica) 8 pre-recorded messages (1 is customizable and recordable only from factory)				•
Temporizzazione infinita / Infinite timing	•	•	•	•
2 LED segnalazione anomalie sul lampeggiante 2 LEDs for anomalies signaling on flashing light	•	•	•	
LED riconoscimento anomalia (su circuito sirena) Anomaly signaling LED (on sounder circuit)	•	•	•	•
Batteria in tampone / Battery: <b>12 V 2.1 Ah Pb o/or 12 V 1.2 Ah Pb</b>	•	•	•	
Condizioni ambientali / Operating temperature: <b>Da/from -25°C a/to +55°C</b>	•	•	•	•
Grado di protezione / Protection level: <b>IP44</b>	•	•	•	•
Dimensioni (HxLxP) / Dimensions (HxLxD): <b>327x216x117 mm</b>	•	•	•	•
Peso (gr.) / Weight (gr.)	2079	2079	2534	2516

## COLORI COLOURS

Coperchio Esterno  
External cover

- Rosso brillante / Shiny red
- Rame / Copper
- Avorio / Ivory
- Bronzo / Bronze
- Acciaio / Grey
- Rosso / Red
- Champagne / Champagne
- Cromo / Chromium  
Colore disponibile con supplemento  
Colour available at extra cost
- Celeste / Light blue

Calotte  
Flash covers

- Rosso / Red
- Fumè / Smoke grey



CENTRALI D'ALLARME  
ALARM CONTROL PANELS



# CENTRALI D'ALLARME

## ALARM CONTROL PANELS

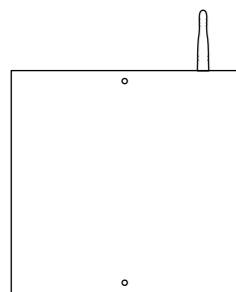

CENTRALE V8-20

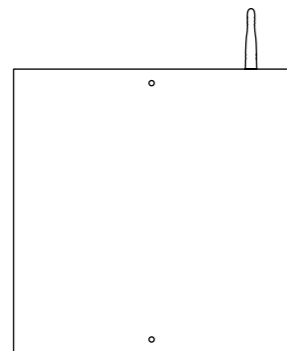

CENTRALE V8-20XL



TASTIERA  
KEYPAD



CHIAVE  
PROXIMITY TAG



INSERITORE  
TAG READER

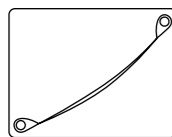

ESPANSIONE  
WIRELESS  
WIRELESS EXPANSION

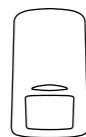

SENSORE  
WIRELESS  
WIRELESS DETECTOR

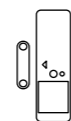

CONTATTO  
WIRELESS  
WIRELESS CONTACT



RADIOCOMANDO  
REMOTE CONTROL

### SIRENA / CENTRALE

#### SOUNDER / ALARM CONTROL PANEL

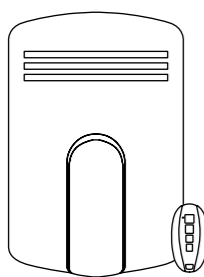

DOGE CT3



# V8-20 / V8-20XL

Semplici da installare, intuitive nella programmazione e nell'utilizzo, flessibili nelle prestazioni, le centrali d'allarme Venitem permettono di realizzare soluzioni di sicurezza personalizzate.

Easy to install, intuitive for programming and using, flexible in performances: Venitem control panels allow customized security solutions.



Design e tecnologia 100% Made in Italy  
100% Made in Italy design and technology

IDEALE PER TUTTI I TIPI DI INSTALLAZIONE  
PERFECT FOR ANY KINDS OF INSTALLATION

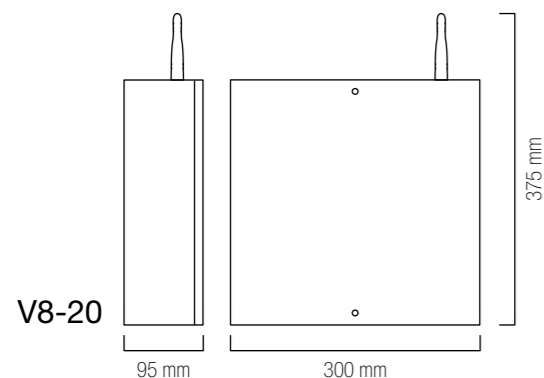

## TASTIERE KEYPADS

Tastiera con LED di segnalazione anomalie e LED di segnalazione stato impianto. Design elegante e verniciatura di alta qualità con possibilità di scelta tra varie colorazioni.

Keypad with anomaly signaling LED and ON/OFF signaling LED. Elegant design, high quality painting and possibility to choose among different colours.

## COLORI COLOURS

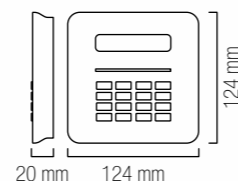
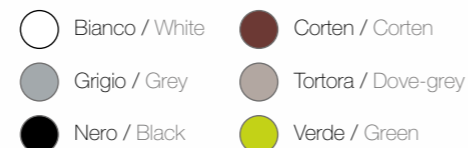

## INFORMAZIONI TECNICHE TECHNICAL INFORMATION

8 linee a bordo  
8 base zones

Possibilità di espandere le linee di base fino a un massimo di 20, in modalità filare o wireless (868 Mhz)  
Possibility to expand the base zones up to MAX 20, in wired or wireless mode (868 Mhz)

2 uscite dedicate per sirena esterna e interna  
2 dedicated outputs for outdoor and indoor sounder

2 uscite relè a stato solido (corrente massima 100 mA) liberamente programmabili  
2 solid-state relay outputs (MAX current 100 mA), freely programmable

Possibilità di espandere le uscite di base fino a un massimo di 8 utilizzando un accessorio a 2 relè o un'espansione su BUS a 4 relè  
Possibility to expand the base outputs up to MAX 8 using a 2-relay accessory or a 4-relay BUS expansion

GSM integrato di serie  
Integrated GSM (standard feature)

Possibilità di integrare un combinatore PSTN  
Possibility to add a PSTN dialer

Alimentatore 13.8 Vdc 1.3 A che, grazie allo speciale trattamento in resina sottovuoto, è in grado di funzionare anche in ambienti molto umidi  
13.8 Vdc 1.3 A power supply able to work even very humid environments thanks to the special treatment in vacuum resin

Preforatura per alloggiare tutte le schede relè Venitem  
Pre-punching to seat all Venitem boards

Bolla di centratura di serie  
Spirit level (standard feature)

Conformità GSM / GSM compliance: EN 60950-1, ETSI EN 301 489-1, ETSI EN 301 489-7, ETSI EN 305 511  
Conformità PSTN / PSTN compliance: EN 60950-1

## CHIAVI PROXIMITY TAGS

Chiavi di prossimità ergonomiche e funzionali, disponibili in varie colorazioni e utilizzabili per selezionare la modalità di funzionamento dell'impianto.

Ergonomic and functional proximity tags to choose the working mode of your alarm system; available in different colours.

## COLORI COLOURS

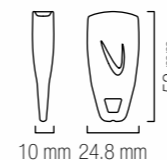

## INSERITORE TAG READER

Inseritore chiave transponder universale  
Universal proximity tag reader



## ESPANSIONE WIRELESS 868 MHZ BI-DIREZIONALE TWO-WAY 868 MHZ WIRELESS EXPANSION



La scheda di espansione wireless permette di modulare l'impianto a seconda delle necessità senza intervenire con opere murarie. Un sistema radio basato sulla comunicazione bi-direzionale tra dispositivi e modulazione a spettro espanso (DSSS), che permette di coprire maggiori distanze.

The wireless expansion module allows the user to set the control panel according to his needs avoiding building modifications. The control panel wireless system is based on two-way communication between devices and direct sequence spread spectrum (DSSS) leading communication to uncommon distances.

## GESTIONE MANAGEMENT

La gestione della centrale può avvenire sia utilizzando l'APP per smartphone dedicata, sia tramite SMS e telegestione vocale per accendere, parzializzare, spegnere e comandare tutte le 8 uscite.

The alarm control panel can be managed using the dedicated APP as well as through vocal telemanagement and SMS. Arming and disarming (even of parts of the alarm system) and managing the 8 outputs becomes easy and fast.



## IL NUOVO CASE XL THE NEW CASE XL

Il nuovo case "XL" è dimensionato per alloggiare una batteria da 17 Ah e un alimentatore per telecamere, consentendo di integrare in uno stesso prodotto la gestione dell'impianto antifurto e di videosorveglianza.

The new "XL" box is able to house a bigger battery (17 Ah) and a CCTV power supply: CCTV and intrusion alarm systems are integrated in the same product.

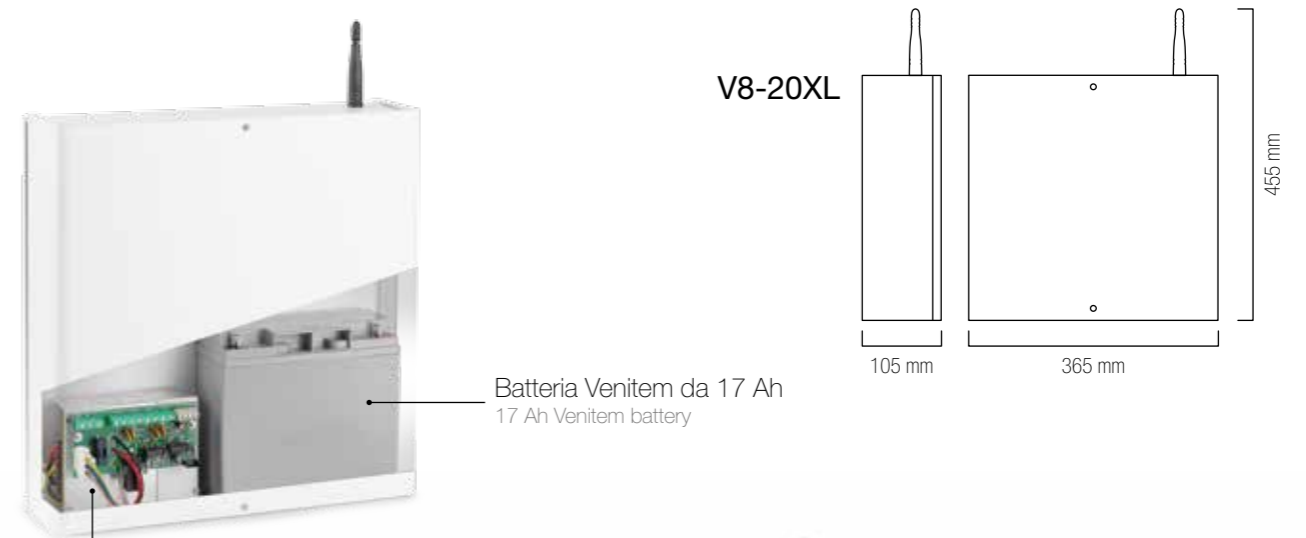

## ANTIFURTO E TVCC INTRUSION AND CCTV

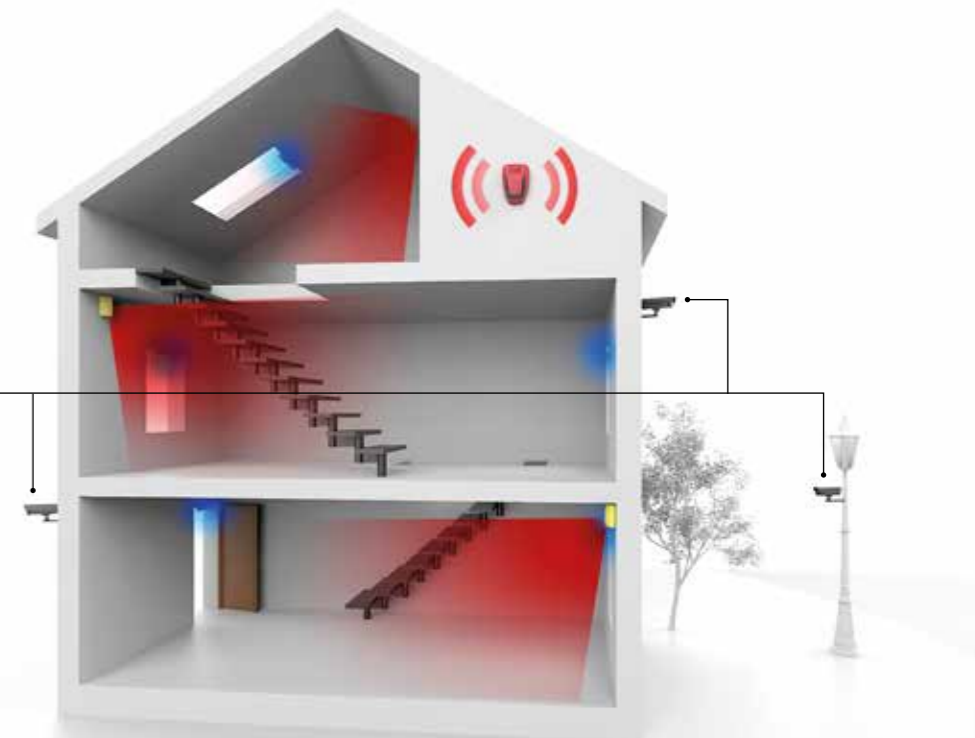

# DOGE CT3

## ALL-IN-ONE SOLUTION

Un prodotto estremamente facile da installare, ideale per piccole installazioni come mini appartamenti, garage, ponteggi.

DOGE CT3 is easy to install and particularly recommended for small applications like mini-flats, garages and scaffoldings.

### ESEMPIO DI INSTALLAZIONE INSTALLATION EXAMPLE

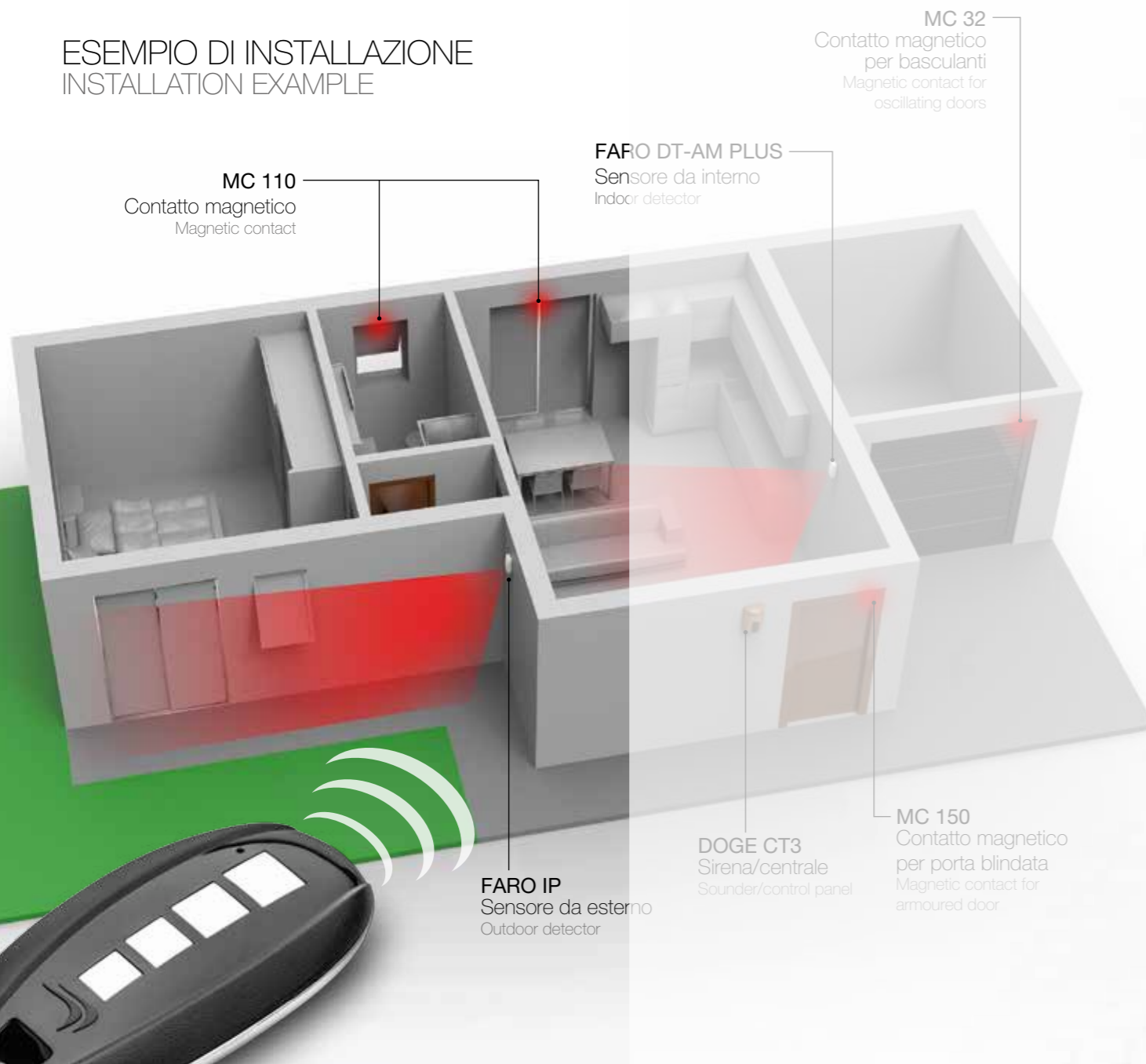

### SIRENA/CENTRALE 3 ZONE 3-ZONE SOUNDER/ALARM CONTROL PANEL

Esempio di applicazione con radiocomando Vela o tastiera Onda Digital W e scheda di espansione.

Application example with Vela remote control or Onda Digital W keypad and expansion board.



3 zone bilanciate espandibili  
3 balanced extensible zones

1 parzializzazione  
1 partialization

Alimentatore 230 Vac  
230 Vac power supply

Lampeggiante a LED  
LED flashing unit

2 suoni programmabili  
2 programmable sounds

Tempo di ingresso/uscita programmabile  
Entrance/exit programmable timing

Comandabile tramite telecomando e/o tastiera wireless  
Manageable through remote control and wireless keypad

Uscita per combinatore telefonico GSM  
Output for GSM phone dialer



ALIMENTATORI:  
TECNOLOGIA MULTIFUNZIONE  
POWER SUPPLIES:  
MULTI-FUNCTION TECHNOLOGY

ALIMENTATORI SPECIALI  
SPECIAL POWER SUPPLIES

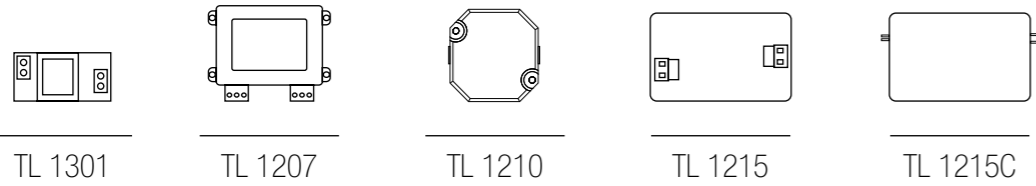

RIDUTTORI DI TENSIONE STABILIZZATI A 12 VDC  
12 VDC STABILIZED TENSION REDUCERS

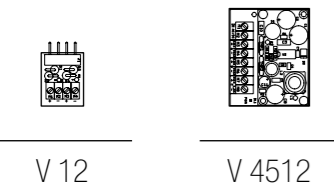

ALIMENTATORI STABILIZZATI PER ANTIFURTO E TVCC A 13.8 VDC E 27.6 VDC  
13.8 VDC AND 27.6 VDC SPECIAL POWER SUPPLIES FOR INTRUSION AND CCTV SYSTEMS

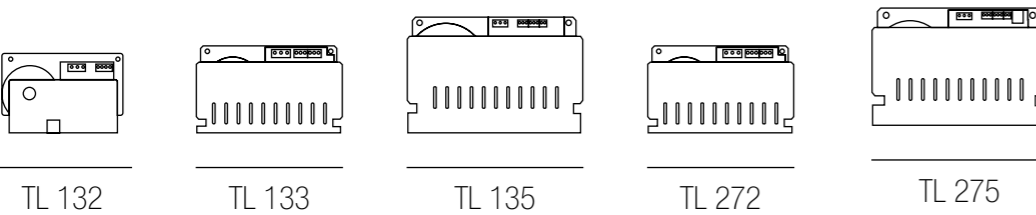

BOX PER ALIMENTATORI  
METAL BOXES FOR POWER SUPPLIES

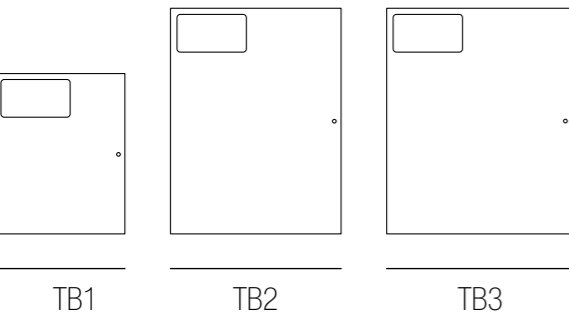

ALIMENTATORI STABILIZZATI IN BOX  
STABILIZED POWER SUPPLIES IN BOX

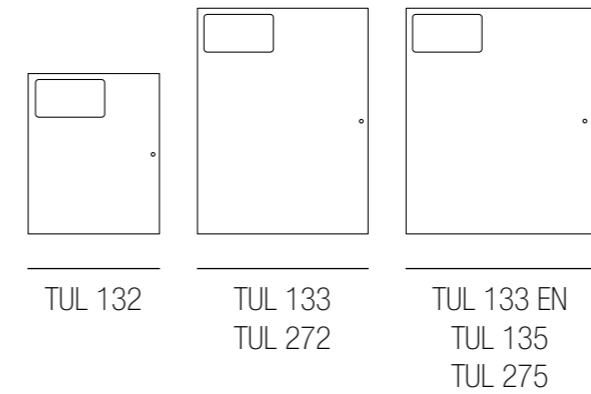

ALIMENTATORI DA ESTERNO A 24 VAC PER TVCC IN BOX STAGNO  
24 VAC OUTDOOR POWER SUPPLIES FOR CCTV IN WATERPROOF BOX

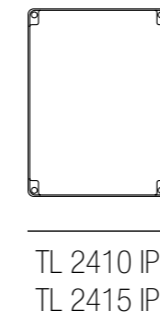

UNITÀ DI ALIMENTAZIONE DA ESTERNO PER TVCC A 12 VDC  
12 VDC OUTDOOR POWER SUPPLIES FOR CCTV



ALIMENTATORI SWITCHING PER TVCC E ANTIFURTO  
CCTV AND ANTI-INTRUSION SWITCHING POWER SUPPLIES

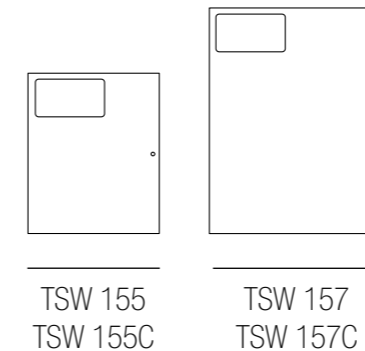

UNITÀ DI ALIMENTAZIONE ANTINCENDIO CERTIFICATE EN 54-4  
EN 54-4 CERTIFIED FIRE POWER SUPPLIES

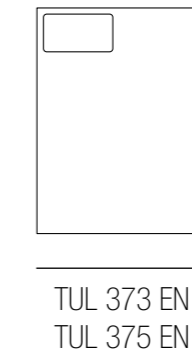



**TL 1301**  
Alimentazione sensori e altre apparecchiature. Ideale per piccoli spazi  
To power detectors and other devices. Perfect for small size locations

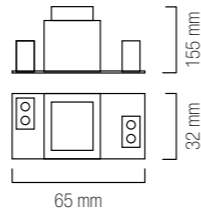

**TL 1207**  
Alimentazione telecamere a 12 Vdc e carica batterie al piombo a 13.8 Vdc  
To power 12 Vdc TV cameras and for 13.8 Vdc lead-battery rechargers

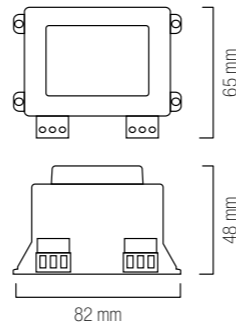

**TL 1210**  
Alimentatore per telecamere a 12 Vdc stabilizzato 1A per ambienti esterni  
Power supply for stabilized 12 Vdc 1 A outdoor TV cameras

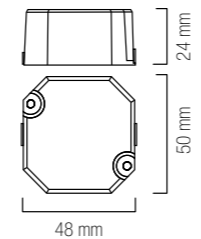

**TL 1215**  
Alimentatore per telecamere a 12 Vdc per ambienti esterni  
Power supply for 12 Vdc outdoor TV cameras

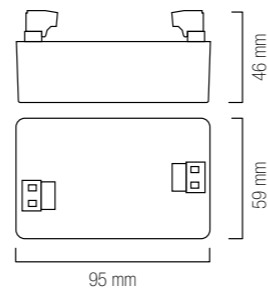

**TL 1215C**  
Alimentatore per telecamere a 12 Vdc per ambienti esterni con cavi  
12 Vdc power supply with cables for outdoor TV cameras

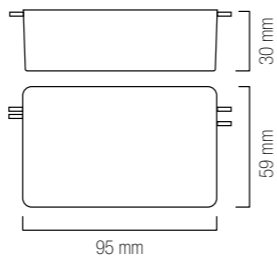

INFORMAZIONI TECNICHE  
TECHNICAL INFORMATION

	TL 1301	TL 1207	TL 1210	TL 1215	TL 1215C
Alimentazione di ingresso Input power supply	230 Vac 50/60 Hz	230 Vac 50/60 Hz	220-240 Vac 50/60 Hz	220 Vac ÷ 240 Vac 50/60 Hz	220 Vac ÷ 240 Vac 50/60 Hz
Tensione di uscita Output voltage	12 Vdc	12 Vdc 13.8 Vdc	12 Vdc	12 Vdc	12 Vdc
Corrente uscita MAX MAX Output current	85 mA	700 mA	1 A	1.5 A	1.5 A
Protezione Protection	PTC	PTC	PTC	PTC	PTC
Temperatura di funzionamento Operating temperature	-10°C ÷ +40°C	-10°C ÷ +40°C	-20°C ÷ +50°C	-10°C ÷ +40°C	-10°C ÷ +40°C
Dati specifici Specific features	Pacchetto batterie ricaricabili da 12V 600 mA Ni-MH Rechargeable 12V 600 mA Ni-MH battery pack	2 uscite 2 outputs	Protezione IP 65 IP 65 protection	Immerso in resina Vacuum resin treatment	Immerso in resina con cavi Vacuum resin treatment with cables
Peso (gr) Weight (gr)	255	486	165	246	246

RIDUTTORI DI TENSIONE STABILIZZATI A 12 VDC  
12 VDC STABILIZED TENSION REDUCERS



**V 12**  
Riduttore di tensione da 13.8 Vdc a 12 Vdc per telecamere a infrarosso e altri prodotti. Peso 14 gr.  
Voltage reducer from 13.8 Vdc to 12 Vdc for infrared tv cameras and other products. Weight 14 gr.

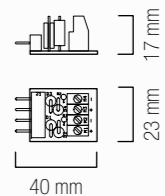

**V 4512**  
Riduttore di tensione da 24 Vdc o 24 Vac a 12 Vdc con LED di segnalazione riduttore attivo e stabilizzatore interno. Uscita regolabile a 13.8 Vdc. Peso 40 gr.  
Voltage reducer from 24 Vdc or 24 Vac to 12 Vdc featuring internal stabilizer and LED signaling when the reducer is activated. Output can be adjusted at 13.8 Vdc. Weight 40 gr.

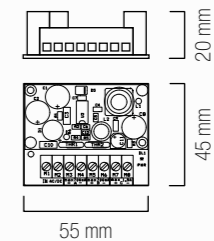



# ALIMENTATORI STABILIZZATI PER ANTIFURTO E TVCC A 13.8 VDC E 27.6 VDC

13.8 VDC AND 27.6 VDC SPECIAL POWER SUPPLIES FOR  
INTRUSION AND CCTV SYSTEMS



## TL 132

Alimentatore 13.8 Vdc 2A con 1 uscita per ricarica batteria e 1 uscita indipendente. Regolazione lineare con trasformatore toroidale.  
13.8 Vdc 2A power supply with 1 output for battery recharge and 1 independent output. Linear regulation with toroidal transformer.

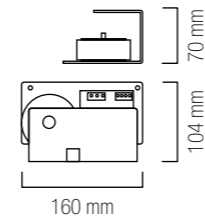

## TL 133

Alimentatore 13.8 Vdc 3A con 1 uscita per ricarica batteria e 2 uscite indipendenti. Regolazione lineare con trasformatore toroidale.  
13.8 Vdc 3A power supply with 1 output for battery recharge and 2 independent outputs. Linear regulation with toroidal transformer.

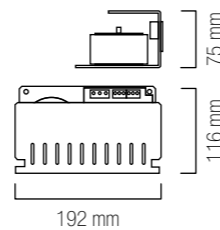

## TL 135

Alimentatore 13.8 Vdc 5A con 1 uscita per ricarica batteria e 3 uscite indipendenti. Regolazione lineare con trasformatore toroidale.  
13.8 Vdc 5A power supply with 1 output for battery recharge and 3 independent outputs. Linear regulation with toroidal transformer.



## TL 272

Alimentatore 27.6 Vdc 2A con 1 uscita per ricarica batteria e 2 uscite indipendenti. Regolazione lineare con trasformatore toroidale.  
27.6 Vdc 2A power supply with 1 output for battery recharge and 2 independent outputs. Linear regulation with toroidal transformer.



## TL 275

Alimentatore 27.6 Vdc 5A con 1 uscita per ricarica batteria e 3 uscite indipendenti. Regolazione lineare con trasformatore toroidale.  
27.6 Vdc 5A power supply with 1 output for battery recharge and 3 independent outputs. Linear regulation with toroidal transformer.

## INFORMAZIONI TECNICHE TECHNICAL INFORMATION

	TL 132	TL 133	TL 135	TL 272	TL 275
Alimentazione di ingresso Input power supply	230 Vac 50/60 Hz	230 Vac 50/60 Hz	230 Vac 50/60 Hz	230 Vac 50/60 Hz	230 Vac 50/60 Hz
Tensione di uscita Output voltage	13.8 Vdc	13.8 Vdc	13.8 Vdc	27.6 Vdc	27.6 Vdc
Corrente uscita MAX MAX Output current	2 A	3 A	5 A	2 A	5 A
Protezione ingresso - uscita Input - Output protection	Fusibili / Fuses	Fusibili / Fuses	Fusibili / Fuses	Fusibili / Fuses	Fusibili / Fuses
Protezione uscita batteria Battery output protection	Fusibile / Fuse	Fusibile / Fuse	Fusibile / Fuse	Fusibile / Fuse	Fusibile / Fuse
Temperatura di funzionamento Operating temperature	-10°C ÷ +40°C	-10°C ÷ +40°C	-10°C ÷ +40°C	-10°C ÷ +40°C	-10°C ÷ +40°C
Peso (gr) Weight (gr)	963	1617	2931	1822	3796



BOX PER ALIMENTATORI  
METAL BOXES FOR POWER SUPPLIES

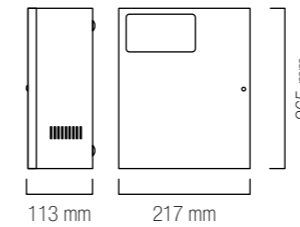

**TB1**

Box metallico verniciato in poliesteri con tamper antiapertura per TL 132. Colore: grigio - peso: 1553 gr.

Metal box for TL 132 featuring polyester painting process and anti-opening tamper. Colour: grey. Weight: 1553 gr.

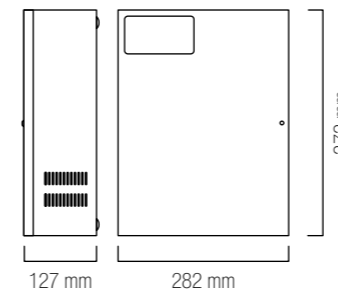

**TB2**

Box metallico verniciato in poliesteri con tamper antiapertura per TL 132 - TL 133 - TL 272. Colore: grigio - peso: 3874 gr.

Metal box for TL 133 - TL 272 featuring polyester painting process and anti-opening tamper. Colour: grey. Weight: 3874 gr.

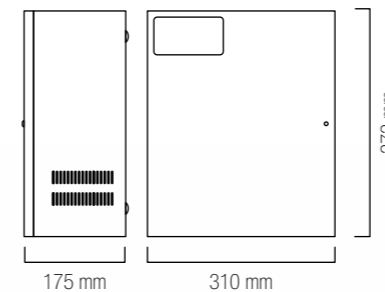

**TB3**

Box metallico verniciato in poliesteri con tamper antiapertura per TL 135 - TL 275 - TL 373 - TL 375. Colore: grigio - peso: 4800 gr.

Metal box for TL 135 - TL 275 - TL 373 - TL 375 featuring polyester painting process and anti-opening tamper. Colour: grey. Weight: 4800 gr.

Elegante box metallico verniciato in poliesteri, completo di tamper antiapertura, funzionale mascherina serigrafata e retroilluminata per la segnalazione di anomalie, guasti e stato della batteria.

Elegant metal box, polyester-powder painting process, equipped with anti-opening tamper and smart backlit label with serigraphy to notify anomalies, failures and battery status.



# ALIMENTATORI STABILIZZATI IN BOX

## STABILIZED POWER SUPPLIES IN BOX

### INFORMAZIONI TECNICHE

TECHNICAL INFORMATION

	<b>TUL 133 EN</b> 	<b>TUL 132</b>	<b>TUL 133</b>	<b>TUL 135</b>	<b>TUL 272</b>	<b>TUL 275</b>
Alimentazione di ingresso Input power supply	230 Vac 50/60 Hz	230 Vac 50/60 Hz	230 Vac 50/60 Hz	230 Vac 50/60 Hz	230 Vac 50/60 Hz	230 Vac 50/60 Hz
Tensione di uscita Output voltage	13.8 Vdc	13.8 Vdc	13.8 Vdc	13.8 Vdc	27.6 Vdc	27.6 Vdc
Corrente uscita MAX MAX Output current	3.5 A	2 A	3 A	5 A	2 A	5 A
Protezione ingresso - uscita Input - Output protection	Fusibili / Fuses	Fusibili / Fuses	Fusibili / Fuses	Fusibili / Fuses	Fusibili / Fuses	Fusibili / Fuses
Protezione uscita batteria Battery output protection	Fusibile / Fuse	Fusibile / Fuse	Fusibile / Fuse	Fusibile / Fuse	Fusibile / Fuse	Fusibile / Fuse
Relè guasto batteria Battery failure relay	-	1 scambio 1 A 1 switch relay 1 A	1 scambio 1 A 1 switch relay 1 A	1 scambio 1 A 1 switch relay 1 A	1 scambio 1 A 1 switch relay 1 A	1 scambio 1 A 1 switch relay 1 A
Relè mancanza rete programmabile Programmable mains failure relay	15" -15'- 60' 120'- 240' - 1 scambio 1 A	15" -15'- 60' 120'- 240' - 1 scambio 1 A	15" -15'- 60' 120'- 240' - 1 scambio 1 A	15" -15'- 60' 120'- 240' - 1 scambio 1 A	15" -15'- 60' 120'- 240' - 1 scambio 1 A	15" -15'- 60' 120'- 240' - 1 scambio 1 A
	15" - 15' - 60' 120' - 240' 1 switch 1 A	15" - 15' - 60' 120' - 240' 1 switch 1 A	15" - 15' - 60' 120' - 240' 1 switch 1 A	15" - 15' - 60' 120' - 240' 1 switch 1 A	15" - 15' - 60' 120' - 240' 1 switch 1 A	15" - 15' - 60' 120' - 240' 1 switch 1 A
Batteria Battery	<b>Grado 3 / Grade 3:</b> 1 12 Vdc 38 Ah <b>Grado 2 / Grade 2:</b> 1 12 Vdc 17 Ah / 1 12 Vdc 24 Ah	1 12 Vdc 7 Ah Pb	2 12 Vdc 7 Ah Pb / 1 12 Vdc 18 Ah Pb	2 12 Vdc 18 Ah Pb	2 12 Vdc 7 Ah Pb	2 12 Vdc 18 Ah Pb
Temperatura di funzionamento Operating temperature	-10°C ÷ +40°C	-10°C ÷ +40°C	-10°C ÷ +40°C	-10°C ÷ +40°C	-10°C ÷ +40°C	-10°C ÷ +40°C
Box / Box	TB3	TB1	TB2	TB3	TB2	TB3
Peso (gr) Weight (gr)	6704	2573	5710	8390	5931	8403

COMBINATORE TELEFONICO  
TELEPHONE DIALER

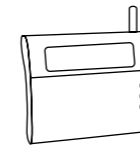

SENSORI DA INTERNO  
INDOOR DETECTORS



SIRENE DA INTERNO  
INDOOR ALARM SOUNDERS



SENSORI DA ESTERNO  
OUTDOOR DETECTORS

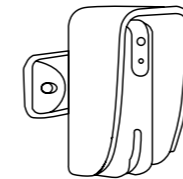

TELECAMERE DOME  
DOME TV CAMERAS

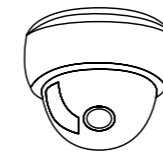

TELECAMERE BULLET  
BULLET TV CAMERAS

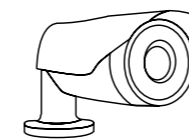

SIRENE DA ESTERNO  
OUTDOOR ALARM SOUNDERS

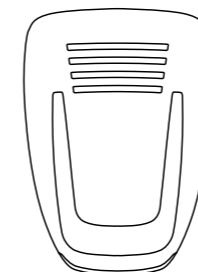

INTERNO  
INDOOR

ESTERNO  
OUTDOOR

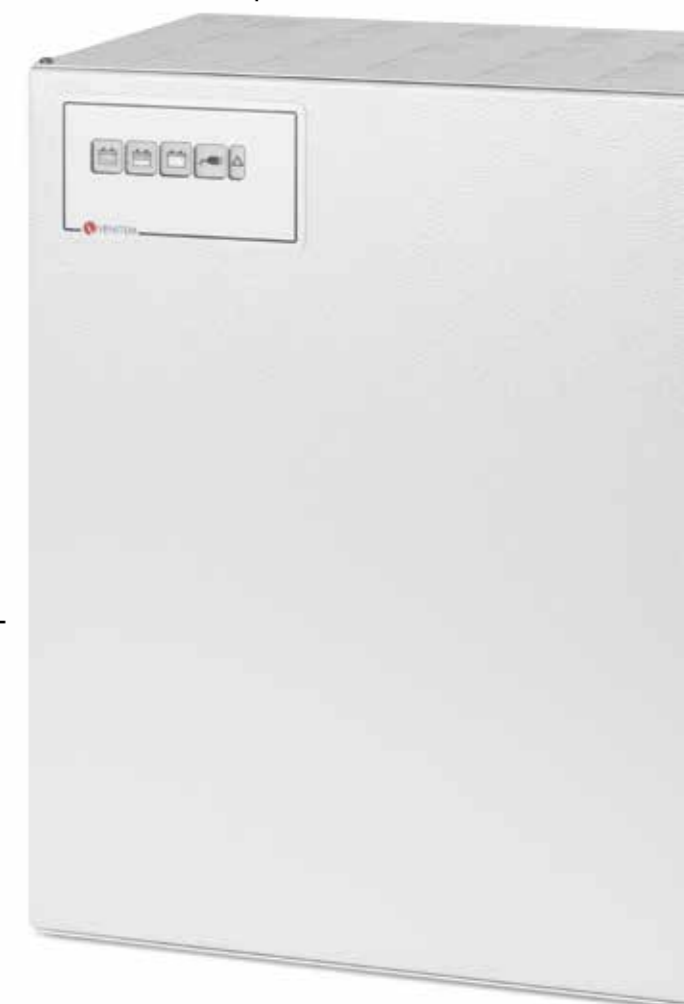

# ALIMENTATORI DA ESTERNO A 24 VAC PER TVCC IN BOX STAGNO

## 24 VAC OUTDOOR POWER SUPPLIES FOR CCTV WITH WATERPROOF BOX

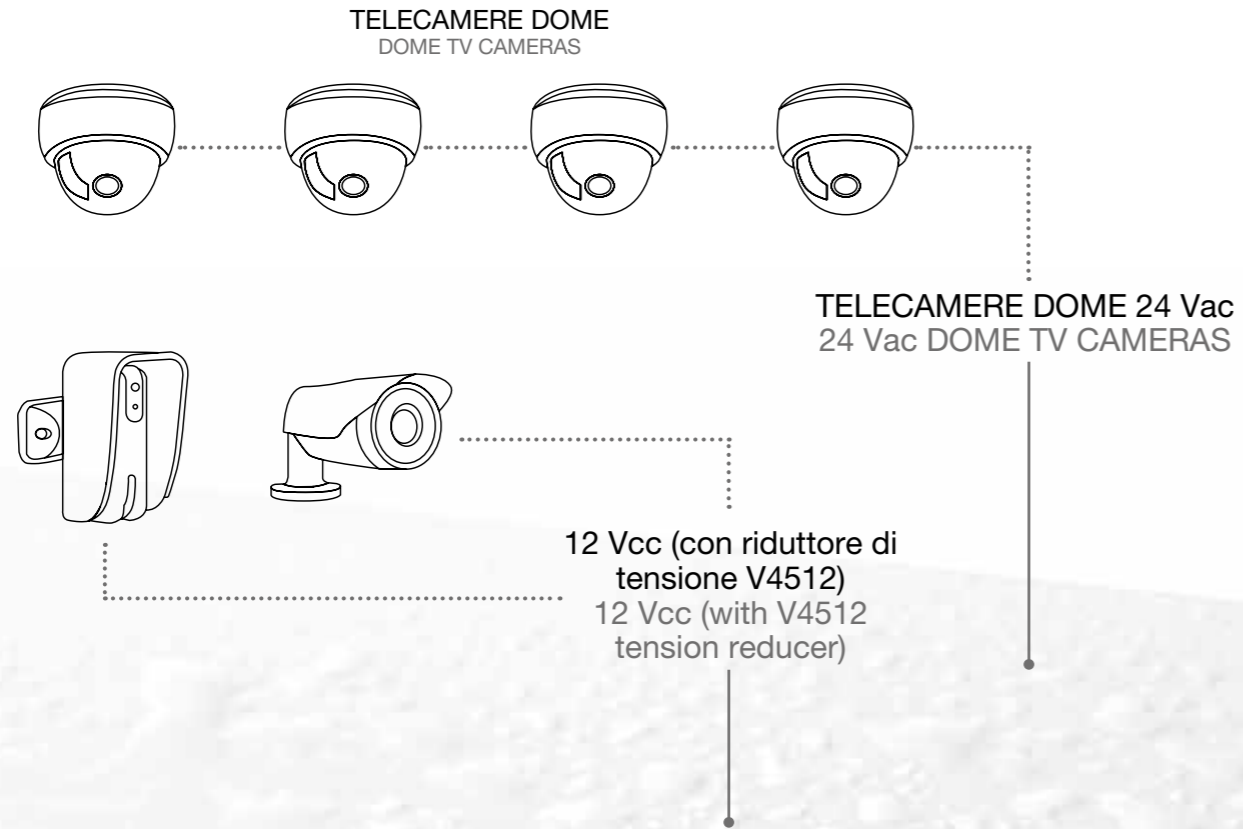

Box stagno in ABS  
ABS waterproof box

Alimentatore a 3.5 A o 5 A 24 Vac  
3.5 A or 5 A 24 Vac power supply

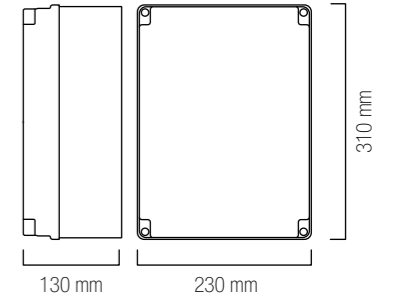

### INFORMAZIONI TECNICHE TECHNICAL INFORMATION

	TL 2410 IP	TL 2415 IP
Alimentazione di ingresso Input power supply	230 Vac 50/60 Hz	230 Vac 50/60 Hz
Tensione di uscita Output voltage	24 Vac	24 Vac
Corrente uscita MAX MAX Output current	3.5 A	5 A
Potenza MAX MAX Power	100 VA	150 VA
Protezione ingresso-uscita Input-output protection	Fusibili Fuses	Fusibili Fuses
Grado di protezione contenitore Box protection level	IP56	IP56
Temperatura di funzionamento Operating temperature	-40°C ÷ +60°C	-40°C ÷ +60°C
Peso (gr) Weight (gr)	3132	3681

Realizzazione su richiesta di alimentatori con diversa potenza o box di altro genere.  
On request, we manufacture power supplies of different power and PSU-boxes of other kinds.

# UNITÀ DI ALIMENTAZIONE DA ESTERNO PER TVCC A 12 VDC

## 12 VDC OUTDOOR POWER SUPPLIES FOR CCTV

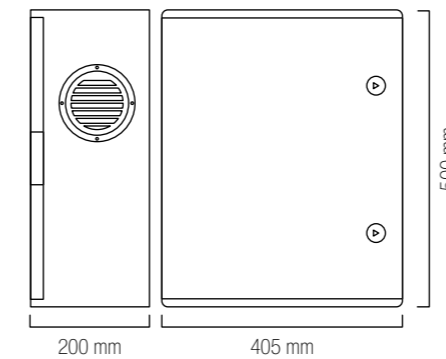
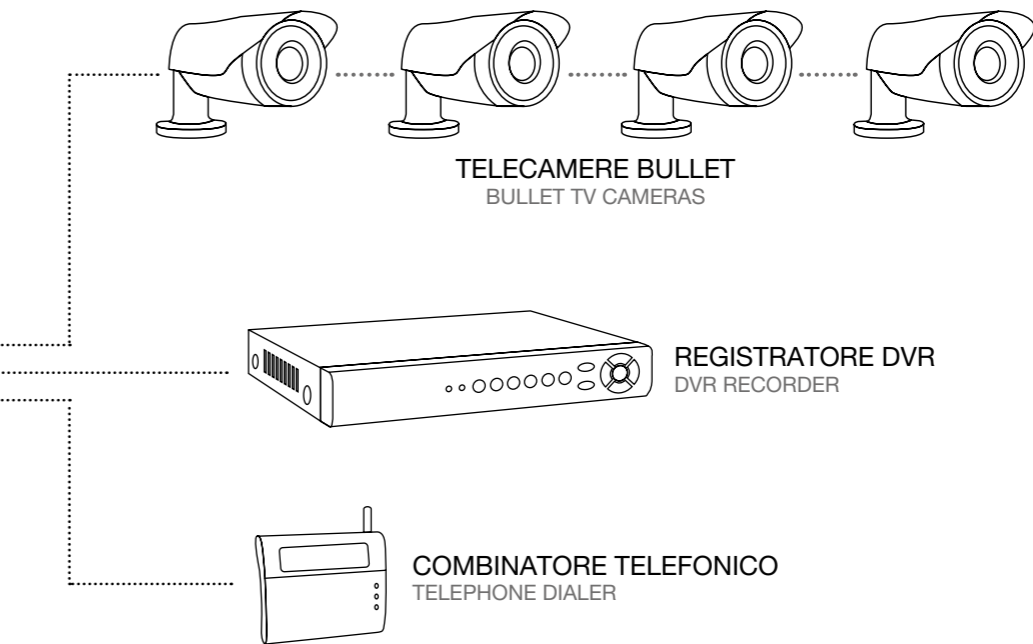
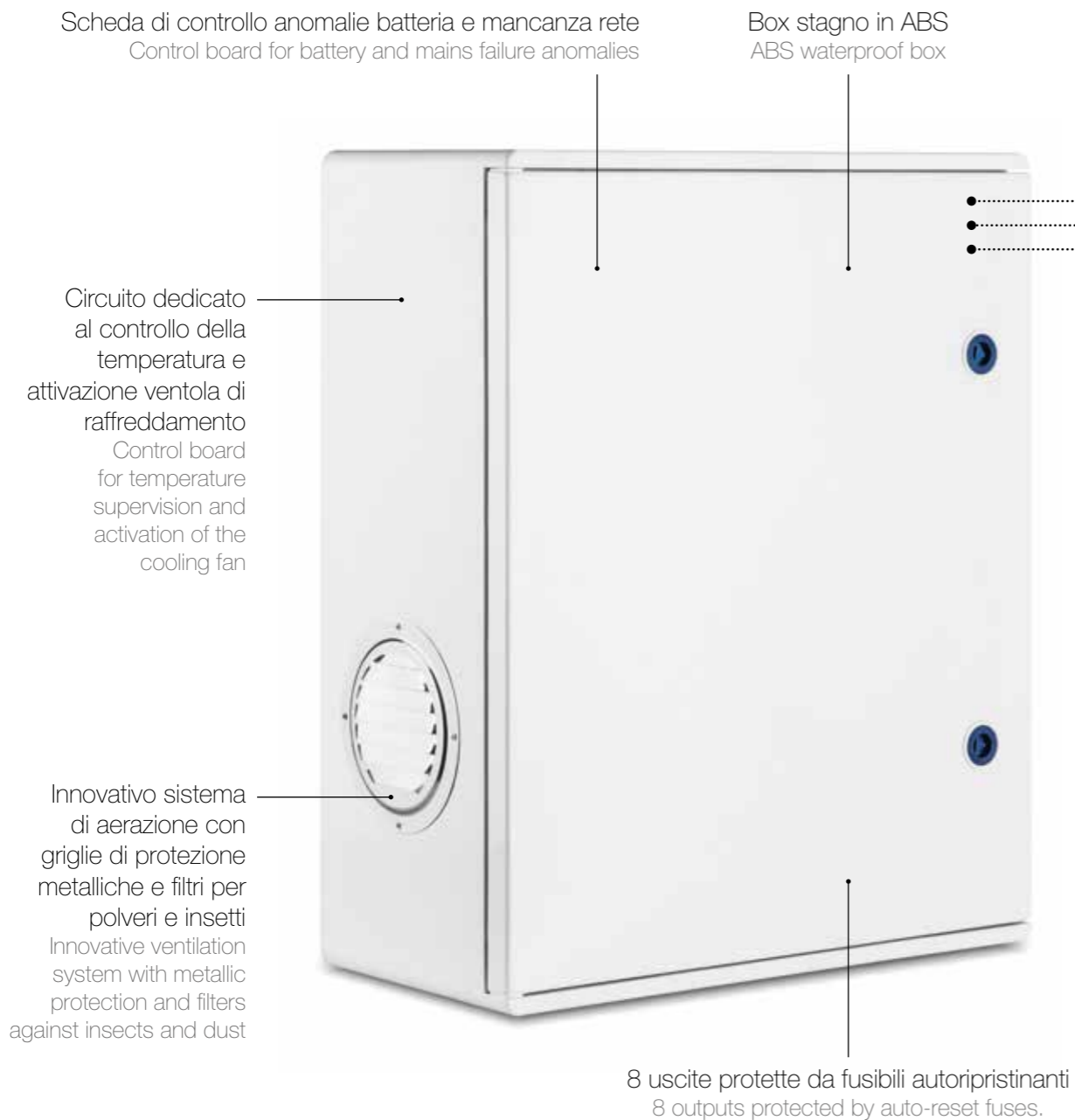

### INFORMAZIONI TECNICHE

#### TECHNICAL INFORMATION

#### TUL 125 IP

Alimentazione di ingresso Input power supply	230 Vac 50/60 Hz
Tensione di uscita Output voltage	12 Vdc
Corrente uscita MAX MAX Output current	5 A
Numero uscite indipendenti Number of independent outputs	8
Protezione ingresso-uscita Input-output protection	Fusibile - Poliswitch Fuse - Polyswitch
Tamper antiapertura Anti-opening tamper	●
Grado di protezione contenitore Box protection level	IP65 senza ventole / without fans
Temperatura di funzionamento Operating temperature	-40°C ÷ +50°C
Peso (gr) Weight (gr)	11150

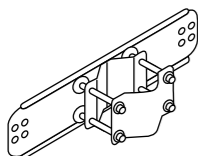

#### OPTIONAL

Staffa per fissaggio a palo (mod. GW46553) per box GEWISS (mod. GW46003)  
Bracket for pole mounting (mod. GW46553) for GEWISS box (mod. GW46003)

# ALIMENTATORI SWITCHING PER TVCC E ANTIFURTO

## CCTV AND ANTI-INTRUSION SWITCHING POWER SUPPLIES

### INFORMAZIONI TECNICHE

TECHNICAL INFORMATION

	<b>TSW 155</b>	<b>TSW 155C</b>	<b>TSW 157</b>	<b>TSW 157C</b>
Alimentazione di ingresso 90-260 Vac freq. 50 - 60 Hz Input power supply 90-260 Vac freq. 50 - 60 Hz	•	•	•	•
Corrente assorbita MAX / Max current consumption	0.6 A	0.6 A	1 A	1 A
Tensione di uscita nominale / Output DC rate voltage	13.8 Vdc	13.8 Vdc	13.8 Vdc	13.8 Vdc
Regolazioni disponibili 12.3V - 12.9V / Available adjustments 12.3V - 12.9V	•	•	•	•
Corrente MAX totale disponibile per le uscite / MAX current available for the outputs	4 A	4 A	6 A	6 A
Corrente MAX di ricarica disponibile per batteria MAX current available for battery recharge	1 A	1 A	1 A	1 A
Numero uscite con fusibile ripristinabile / Number of outputs with auto-reset fuses	4	4	8	8
LED segnalazione sovraccarico uscita (fusibile riprist. aperto) LED for output overload notice (open auto-reset fuse)	4	4	8	8
Possibilità di collegamento uscite in parallelo / Possibility to connect outputs in parallel	•	•	•	•
Protezione contro inversione della polarità batteria Protection against battery polarity inversion	•	•	•	•
Display con presenza rete, guasto, batteria scarica, batteria sovraccaricata, batteria OK Display showing: mains on, failure, low battery, overcharged battery, battery OK		•		•
Relè: guasto, batteria scarica, fusibili aperti / Relay: failure, low battery and open fuses		•		•
Relè: mancanza rete programmabile / Relay: mains failure with programmable delay		•		•
Alloggiamento batteria Battery housing	12V 12Ah o/ or 12V 7Ah	12V 12Ah o/ or 12V 7Ah	12V 18Ah o/ or 12V 12Ah	12V 18Ah o/ or 12V 12Ah
Tamper antiapertura / Anti-opening tamper	•	•	•	•
Temperatura di funzionamento: da -10 °C a +40 °C Operating temperature: from -10 °C to +40 °C	•	•	•	•
Umidità senza condensa / Operating humidity (without moisture)	75%	75%	75%	75%
Box / Box	TB1	TB1	TB2	TB2
Peso (gr) / Weight (gr)	2310	2352	5039	5104
Ambienti di installazione: al riparo da agenti atmosferici Working enviroment: sheltered from weathering	•	•	•	•

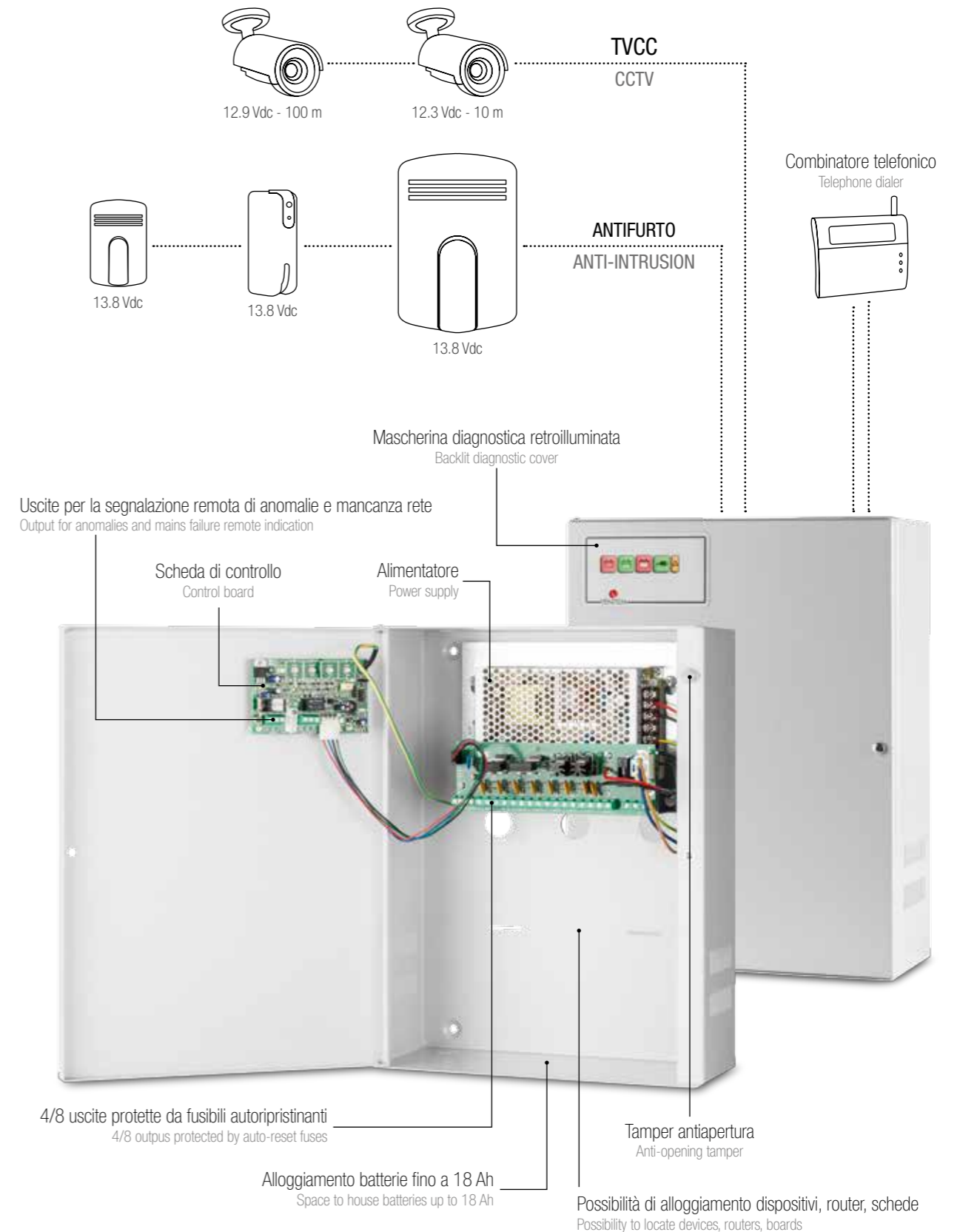

# UNITÀ DI ALIMENTAZIONE ANTINCENDIO CERTIFICATE EN 54-4

## EN 54-4 CERTIFIED FIRE POWER SUPPLIES



	TUL 375 EN	TUL 373 EN
Alimentazione di ingresso 230 Vac freq. 50 Hz Input power supply 230 Vac freq. 50 Hz	•	•
Alimentazione di uscita / Output power supply	27.6 Vdc	27.6 Vdc
Corrente MAX uscita / MAX Output current	5 A	3 A
Protezione ingresso - uscite Input-output protection	Fusibili Fuses	Fusibili Fuses
Protezione uscita batteria Battery output protection	Fusibile Fuse	Fusibile Fuse
Relè di guasto batteria Battery failure relay	1 scambio 1A 1 switch relay 1A	1 scambio 1A 1 switch relay 1A
Alloggiamento batteria Battery housing	2 x 12V 17Ah Pb	2 x 12V 17Ah Pb
Tamper antiapertura / Anti-opening tamper	Micro switch	Micro switch
Temperatura operativa : da -10 °C a +40 °C Working temperature: from -10 °C to +40 °C	•	•
Umidità relativa Relative humidity	da/from 5% a/to 93% ± 2%	da/from 5% a/to 93% ± 2%
Box / Box	TB3	TB3
Peso (gr) / Weight (gr)	9100	8200
<b>Certificato UNI EN 54-4:2007 n.0051-CPR-0267</b> UNI EN 54-4:2007 n.0051-CPR-0267 Approval	•	
<b>Certificato UNI EN 54-4:2007 n.0051-CPR-0266</b> UNI EN 54-4:2007 n.0051-CPR-0266 Approval		•
<b>Certificata secondo regolamento Europeo n° 305/2011/EU</b> (Construction Products Regulation - CPR) <b>Certified according to European regulation n° 305/2011/UE</b> (Construction Products Regulation - CPR)	•	•



Alimentatori certificati con prove di laboratorio effettuate con batterie YUASA.  
Lab tests for the certification of these power supplies were performed using YUASA batteries.

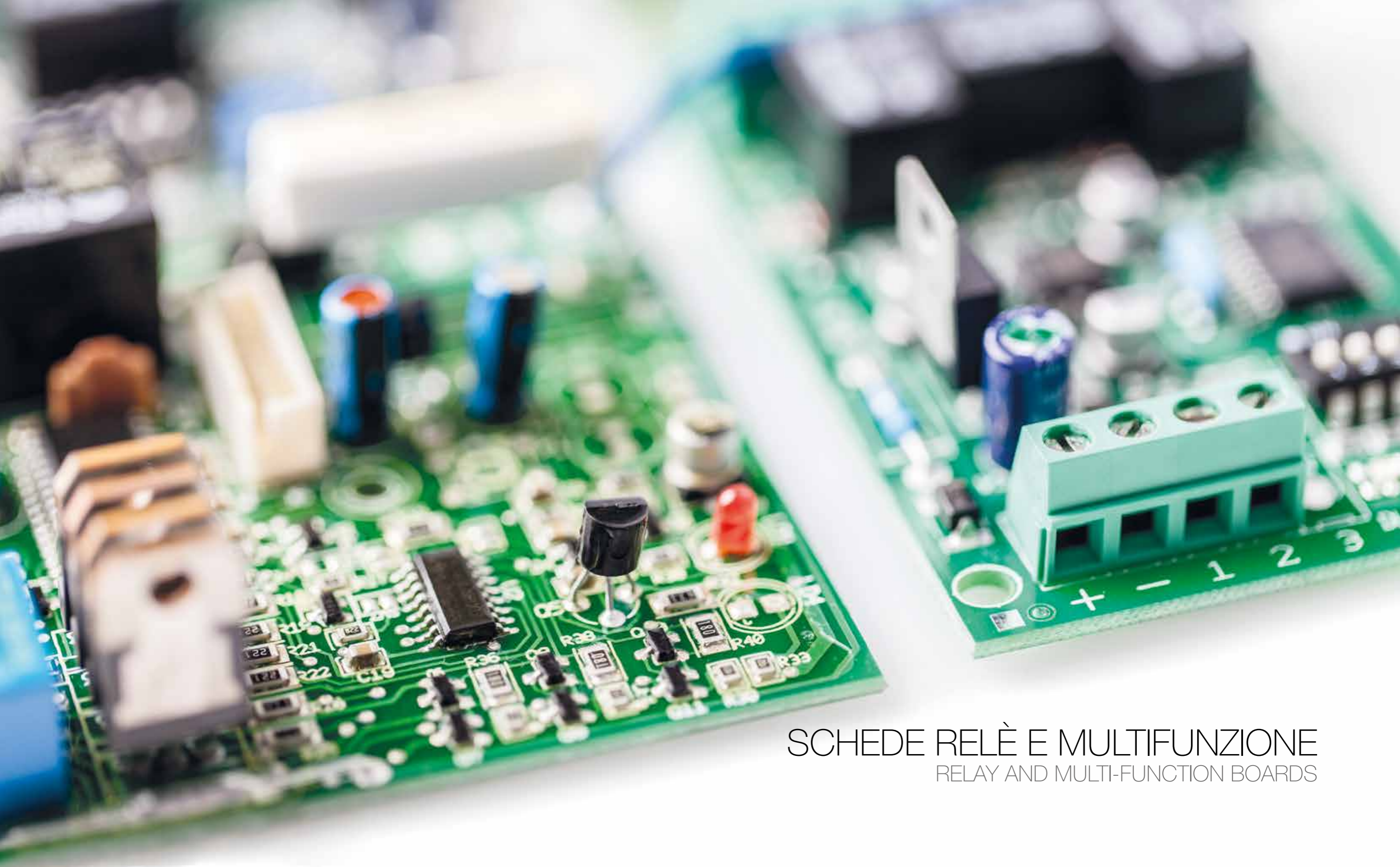

SCHEDA RELÈ E MULTIFUNZIONE  
RELAY AND MULTI-FUNCTION BOARDS





Fino a otto programmazioni differenti e con diverse temporizzazioni in un unico prodotto. Venitem è riuscita ad ottenere questa flessibilità nell'utilizzo delle schede relè, in grado di moltiplicare all'infinito la propria capacità di gestione. Numerose applicazioni **per impianti antifurto, TVCC e automazione domotica**, il tutto unito alla funzionalità del contenitore protettivo DIN BOX di misura standard, che consente l'installazione dei circuiti nei quadri elettrici e dove siano presenti numerosi cablaggi, e permette il montaggio in serie di più schede, grazie al comodo aggancio ad incastro laterale.

Till 8 different programming and with different timing options in one product. Venitem has been able to obtain this flexibility and operating capability through its relay boards. Many functions for **intrusion, CCTV and domotics automation**, comes together with the DIN BOX standard plastic box, allowing board installation in switchboards and systems having huge quantities of cables. Moreover, the DIN BOX enables different modules to be mounted in series thanks to its useful lateral snap-fit hook.

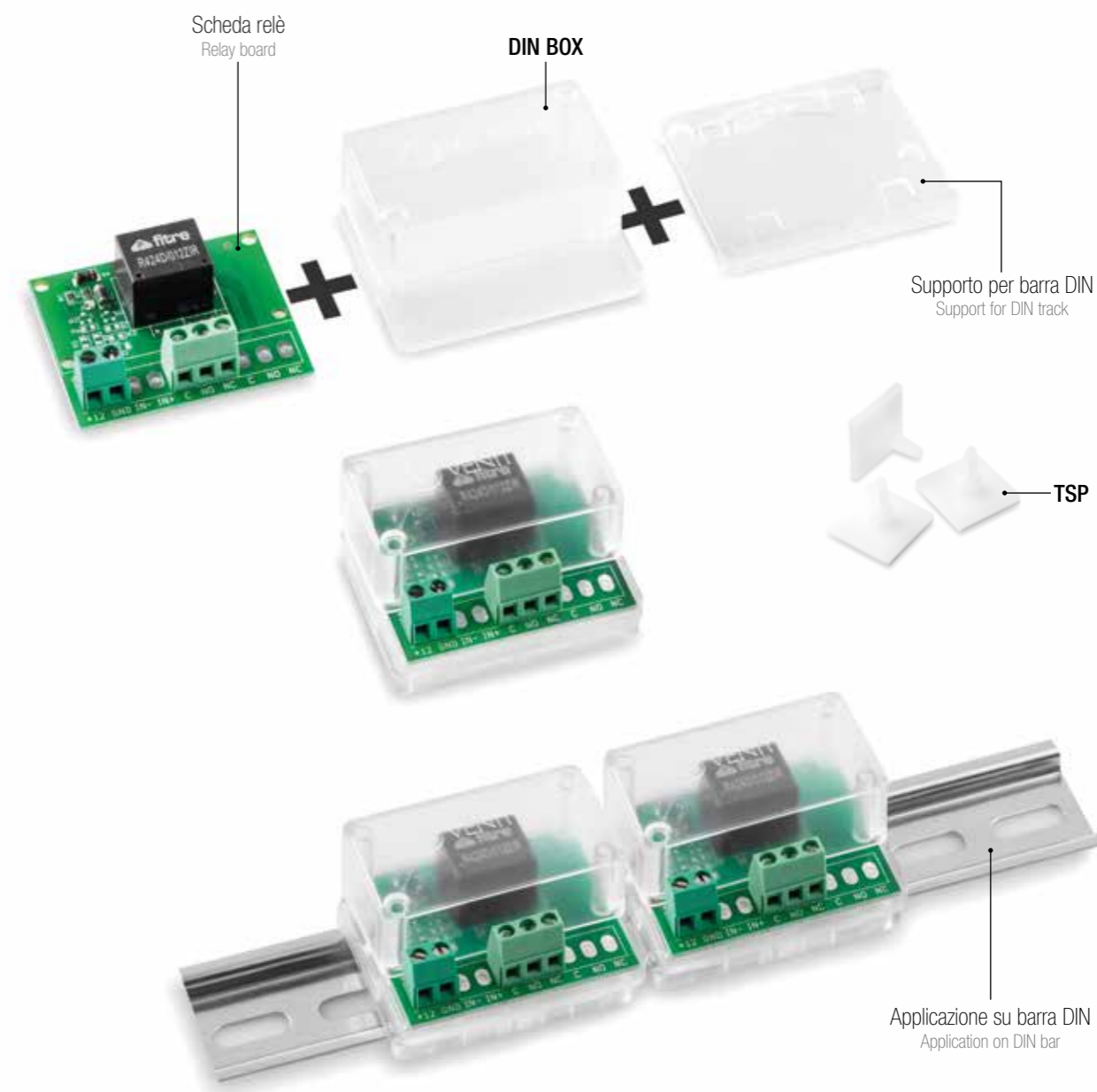

### DIN BOX

Contenitore plastico protettivo con possibilità di fissaggio su barra DIN (utilizzabile con RA - RA/T - RA/2S - RN 12/24 - MTT - MCX - MCV) Dimensioni: 59x48x26 mm (HxLxD) - peso: 22 gr.

Protective plastic box with mounting option on DIN track - (usable with RA - RA/T - RA/2S - RN 12/24 - MTT - MCX - MCV)  
Dimensions: 59x48x26 mm (HxLxD) - weight: 22 gr.

### TSP

Supporto plastico adesivo per schede relè e schede multifunzione  
plastic bracket for relay and multi-function boards

## SCHEDE RELÈ RELAY BOARDS



### RA

Scheda per open collector con uscita a relè.  
Circuito interfaccia a un ingresso da 35mA e un'uscita relè da 3A.  
Dimensioni: 55x45x18 mm (HxLxD) - peso: 24 gr.  
Module for open collector with relay output.  
Interface board with a 35mA input and a 3A relay output.  
Dimensions: 55x45x18 mm (HxLxD) - weight: 24 gr.



### RA/T

Scheda a basso assorbimento per open collector con uscita a relè.  
Circuito interfaccia a un ingresso da 1mA e un'uscita relè da 3A.  
Dimensioni: 55x45x18 mm (HxLxD) - peso: 26 gr.  
Low consumption module for open collector with relay output.  
Interface board with a 1mA input and a 3A relay output.  
Dimensions: 55x45x18 mm (HxLxD) - weight: 26 gr.



### RA/2S

Scheda a basso assorbimento per open collector con due uscite isolate. Circuito interfaccia a un ingresso da 1mA e due uscite relè da 1A. Dimensioni: 55x45x17 mm (HxLxD) - peso: 26 gr.  
Low consumption module for open collector with two opto-isolated outputs.  
Interface board with a 1mA input and two 1A relay outputs.  
Dimensions: 55x45x17 mm (HxLxD) - weight: 26 gr.



### RN 12/24

Scheda per open collector con due ingressi e due uscite a relè. Circuito interfaccia a due ingressi da 25mA e due uscite a due relè da 1A. Dimensioni: 55x45x17 mm (HxLxD) - peso: 30 gr.  
Module for open collector with two relay inputs and two relay outputs. Interface board with two 25mA inputs two outputs with two 1A relays.  
Dimensions: 55x45x17 mm (HxLxD) - weight: 30 gr.

## SCHEDE MULTIFUNZIONE MULTI-FUNCTION BOARDS



### CTT/R

Circuito di segnalazione mancanza rete e anomalia batteria - ingresso optoisolato - tre relè di uscita da 1A.  
Dimensioni: 85x50x20 mm (HxLxD) - peso: 40 gr.  
Circuit for mains failure and battery anomaly signaling - opto-isolated input - three 1A output relays.  
Dimensions: 85x50x20 mm (HxLxD) - weight: 40 gr.



### MTT

Circuito multifunzione per tutte le temporizzazioni - due ingressi da 1mA - un'uscita relè da 1A - un'uscita O.C.  
Dimensioni: 55x45x18 mm (HxLxD) - peso: 23 gr.  
Multi-function board for all timings - two 1mA inputs - a 1A relay output - a O.C. output.  
Dimensions: 55x45x18 mm (HxLxD) - weight: 23 gr.



### MCX

Circuito multifunzione per contatti tapparelle, serrande, sensori inerziali, vibrazioni - un ingresso da 1mA - un'uscita relè da 1A - un'uscita O.C.  
Dimensioni: 55x45x18 mm (HxLxD) - peso: 23 gr.  
Multi-function board for rolling shutters, inertial sensors, vibrations - a 1mA input - a 1A relay board - a O.C. output.  
Dimensions: 55x45x18 mm (HxLxD) - weight: 23 gr.



### MCV

Circuito multifunzione per contatti tapparelle e magnetici (fino a 4 totali), un'uscita relè da 1A e un'uscita opto-isolata.  
Dimensioni: 55x45x18 mm (HxLxD) - peso: 25 gr.  
Multi-function circuit for shutters and magnetic contacts (till 4 totally) - a 1A relay output - a opto-isolated output.  
Dimensions: 55x45x18 mm (HxLxD) - weight: 25 gr.



ALTRI PRODOTTI  
OTHER PRODUCTS

# CONTATTI MAGNETICI

## MAGNETIC CONTACTS



### MC 32

Contatto magnetico per basculanti in lega metallica (MC32) o in plastica (MC32P), prismatico supercorazzato, reed elettro isolato. Distanza di funzionamento: 30 mm.

Prismatic magnetic contact for oscillating doors, metal structure (MC32) or plastic structure (MC32P), armoured, electrically insulated reed. Average operating distance: 30 mm.

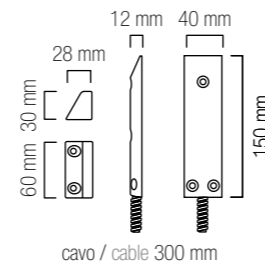

### MC 150

Contatto magnetico da incasso in plastica, alta tolleranza (porta blindata), connessione a vite. Distanza di funzionamento su legno/plastica: 20 mm - su ferro: 10 mm. Disponibile nei colori bianco (MC 150B) e marrone (MC 150M).

Plastic magnetic contact for flush mounting, high tolerance (armoured door), screw connection. Max operating distance on wood/plastic: 20 mm - on iron: 10 mm. Available colours: white (MC 150B) brown (MC 150M).

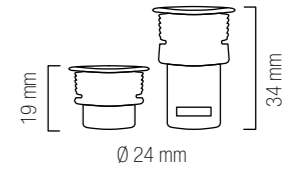

### MC 50

Sensore inerziale a vibrazione in ABS per rilevazione urti. Versione da incasso.

Inertial vibration sensor in ABS for shock detection. Flush mounting.

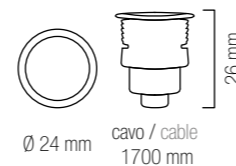

### MC 200

Contatto magnetico in plastica, montaggio a vista con connessione e installazione a vite a scomparsa. Distanza massima di funzionamento su legno/plastica: 20 mm - su ferro: 10 mm. Colori disponibili: bianco (MC 200B) - marrone (MC 200M).

Plastic magnetic contact, surface mounting with hidden screw connection and installation. Max operating distance on wood/plastic: 20 mm - on iron: 10mm. Available colours: white (MC 200B) - brown (MC 200M).

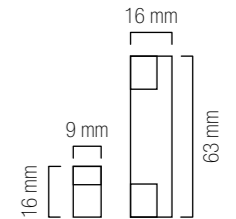

### MC 100

Contatto magnetico da incasso in ottone con cavo tamper. Distanza di funzionamento: 12 mm.

Magnetic contact for flush mounting, brass housing, tampering wire. Average operating distance: 12 mm.

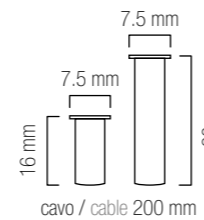

### MC 210

Contatto magnetico in plastica a 2 conduttori, montaggio a vista. Distanza di funzionamento: 15 mm. Colori disponibili: bianco (MC 210B) - marrone (MC 210M).

Plastic magnetic contact, surface mounting, with 2 wires. Average operating distance: 15 mm. Available colours: white (MC 210B) - brown (MC 210M).

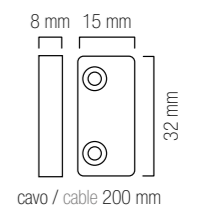

### MC 110

Contatto magnetico da incasso, in plastica, con cavo tamper. Distanza di funzionamento: 12 mm.

Magnetic contact for flush mounting, plastic housing, tampering wire. Average operating distance: 12 mm.

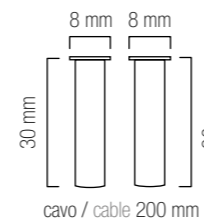

### MC 250

Contatto magnetico extrapiatto per montaggio a vista, con corpo in plastica, doppio magnete a 2 conduttori. Distanza di funzionamento: 15 mm.

Plastic-housing magnetic contact, extra-slim, surface mounting, double magnets, 2 wires. Average operating distance: 15 mm.

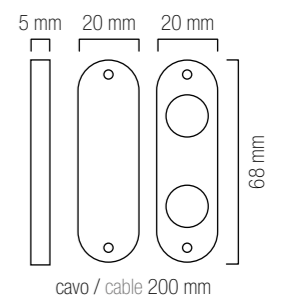



### MC 310

Contatto magnetico prismatico in lega metallica, reed elettro isolato, applicazione a vista (per portoncini in ferro). Distanza massima di attivazione: 12 mm.

Prismatic magnetic contact made of metal-alloy, electrically insulated reed, surface mounting (for iron gates). Max operating distance: 12 mm

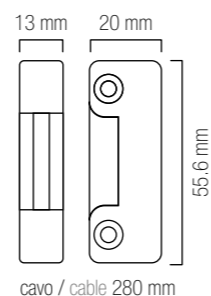

### MC 800

Contatto in plastica per tapparelle con terminazione a morsetto.

Roller shutter plastic contact with terminal block output.

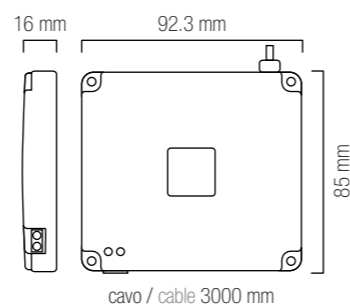

### MC 800W

Contatto per tapparelle in plastica a reed magnetico con terminazione a morsetto - **a basso assorbimento ideale per soluzioni radio.**

Roller shutter plastic contact with magnetic reed and terminal block output - **low consumption, suitable for wireless solutions.**

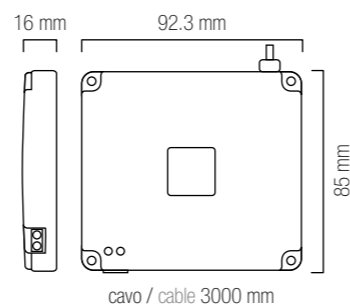

### ST 800

Staffa metallica per passaggio corda contatto a tapparella MC 800 e MC 800W.

Metal bracket for rope passing for MC 800 and MC 800W.

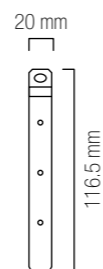

**Su richiesta, si eseguono metrature particolari della lunghezza dei cavi**  
On request, we supply contacts with special lengths of the cables



## PANNELLI E SIRENE PER USCITE DI EMERGENZA PANELS AND SOUNDERS FOR EMERGENCY EXIT



Predisposto per montaggio ad incasso  
Possibility of flush installation

**TP US TP USA TP US VOCAL**

Ingresso di sincronismo / Sync input			•
Alimentazione di ingresso / Input power supply: <b>Vdc</b>	12/24	12/24	12 o/or 24
Alimentatore 230 Vac / 230 Vac power supply		•	
Batterie ricaricabili Ni-MH 9.6 Vdc 1000 mA / Rechargeable 9.6 Vdc 1000 mA Ni-MH batteries		•	
Ingresso contatto porta NC / Input door switch NC	1	1	3
Uscita scambio relè 1A per segnalazione contatto porta / 1A output relay for door contact signaling	•	•	
Chiave meccanica per esclusione e/o reset / Mechanical key for exclusion and/or reset	•	•	•
Segnalazione a LED di: stato impianto, memoria allarme, uscita negativa anomalia per allarme LED signaling for: system state, alarm memory, negative output for alarm anomalies	•	•	
Illuminazione a LED ad altissima luminosità e basso assorbimento / High-brightness low consumption LED	•	•	•
8 messaggi pre-registrati di cui 1 personalizzabile (registrabile solo da fabbrica) 8 pre-recorded messages (1 is customizable and recordable only from factory)			•
Pellicola in policarbonato serigrafata con testo personalizzabile / Polycarbonate film with customizable serigraphy	•	•	•
Peso (gr.) / Weight (gr.)	663	942	915

### TRIADE UE

Sirena autoalimentata per uscite di emergenza a 12 Vdc (o 230 Vac con l'alimentatore TL 1207 - non incluso) con LED lampeggiante per segnalazione stato impianto e LED fisso per memoria allarme. Peso: 1700 gr.

Self-powered 12 Vdc (or 230 Vac using TL 1207 power supply - not included) sounder for emergency exit with flashing LED for system state signaling and steady LED for alarm memory. Weight: 1700 gr.

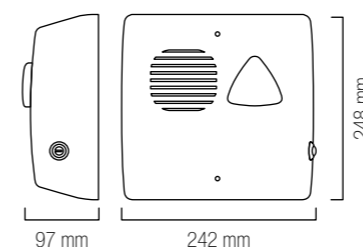

### TCH

Serratura a chiave meccanica a due posizioni con contatto 250 Vac 3A per sirene e pannelli uscita di emergenza. Peso: 54 gr.

Mechanical key for sounders and panels for emergency exit. Two positions and 250 Vac 3A contact. Weight: 54 gr.

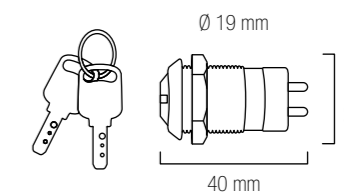

## SEGNALATORI OTTICO - ACUSTICI OPTICAL - ACOUSTIC SIGNALERS

### RLI 3-30V

Ripetore da incasso a luce fissa (LED rosso di serie) – alimentazione da 3 Vdc a 30 Vdc – consumo: 10 mA – Peso: 8 gr.

Steady-light repeater for flush installation (red LED standard) – power supply from 3 Vdc to 30 Vdc – consumption: 10 mA – Weight: 8 gr.

Disponibile anche in versione con LED colorati (bianco, verde, blu e giallo).  
Also available with coloured LEDs (white, green, blue and yellow).

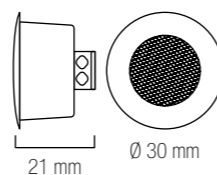

Supporto disponibile nei colori / Support is available in the following colours:



### RL 3V-12/24V

Ripetore a luce fissa – alimentazione 3 Vdc o 12/24 Vdc. Peso: 23 gr.  
3 Vdc or 12/24 Vdc steady-light repeater. Weight: 23 gr.

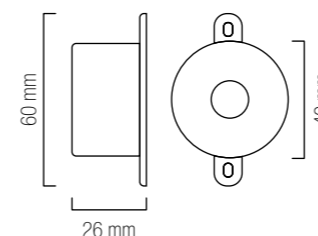
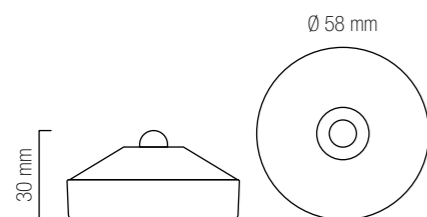

### BZ 96

Buzzer piezoelettrico – alimentazione 3-24 Vdc – assorbimento 13 mA – potenza sonora 96 dB (A) a 1 m. Peso: 20 gr.

Piezoelectric buzzer – power supply 3-24 Vdc – consumption 13 mA – sound power 96 dB (A) at 1 m. Weight: 20 gr.

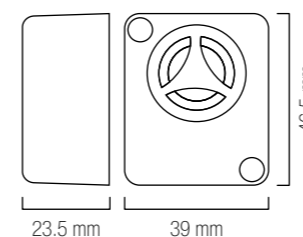

### BZ 100

Buzzer di potenza – alimentazione 6-15 Vdc – assorbimento 130 mA MAX – potenza sonora 108 dB (A) a 30 cm. Peso: 30 gr.

High-power buzzer – power supply 6-15 Vdc – consumption 130 mA MAX – sound power 108 dB (A) at 30 cm. Weight: 30 gr.

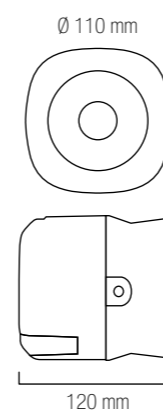

### TR 400

Tromba magnetodinamica di alta potenza ideale per ambienti industriali con forte rumore di fondo. Frequenza di suono modulata – protezione contro l'inversione di polarità – circuito elettronico tropicalizzato con resina ad immersione. Alimentazione 12 V – assorbimento 800 mA – potenza sonora 118 dB (A) a 1 m – frequenza di suono 2400 Hz modulata – dotazione staffa di fissaggio. Peso: 1091 gr.

High power magneto-dynamic horn, suitable for very noisy industrial locations. Modulated sound frequency, protection against polarity inversion and electronic circuit tropicalized through resin immersion. Power supply 12 V – consumption 800 mA – sound power 118 dB (A) at 1 m – sound frequency 2400 Hz modulated – fixing clamp included. Weight: 1091 gr.



# ONDA LUX

Lampeggiante da parete a 12/24 Vdc a basso consumo configurabile a luce fissa o lampeggiante.

Versione combinata LED rosso/verde o bianco/blu – applicabile su scatola da incasso 503. Protezione IP 54. Peso: 213 gr.

Wall flashing light 12/24 Vdc, low consumption, light can be set in fixed and flashing mode.

Combined version with red/green or white/blue LEDs. Installable in 503 box. IP 54 protection. Weight: 213 gr.



# FL100 LED

Lampeggianti a LED con lampeggi regolabili da 50 a 100 al minuto – alimentazione 12/24 Vdc – base in ABS e lenti in VEDRIL – circuito elettronico protetto in resina e contro l'inversione di polarità. Grado di protezione IP 55. Peso: 260 gr.

LED flashing light with adjustable blinks from 50 to 100 per minute – power supply 12/24 Vdc – base in ABS and lens in VEDRIL – electronic circuit protected through resin immersion and against polarity inversion. Protection IP 55. Weight: 260 gr.

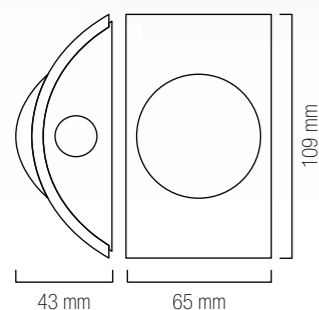

**Montaggio verticale e orizzontale**  
Vertical and horizontal mounting

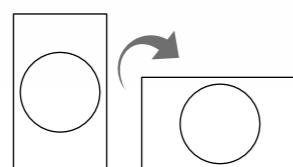

**Compatibile con BOX 503**  
BOX 503 compatible

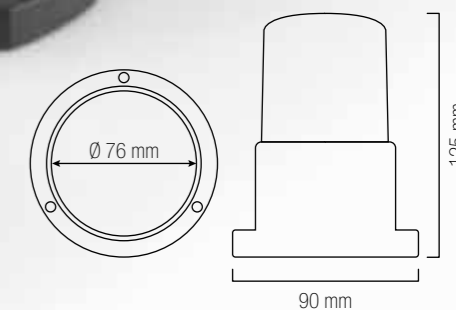
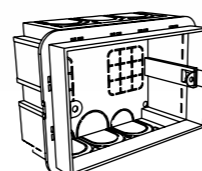



## TASTIERE WIRELESS WIRELESS KEYPADS

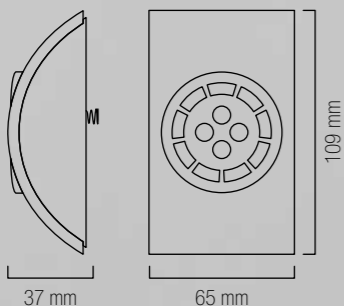

## ONDA DIGITAL W

ONDA DIGITAL W è una tastiera wireless studiata per consentire la gestione di diverse tipologie di sistema, installabile anche in zone dell'abitazione o dell'edificio dove non sia possibile intervenire con un cablaggio. Unisce un design elegante, una solida struttura in metallo grigio satinato ad una funzionale tastiera retroilluminata. ONDA DIGITAL W è un prodotto estremamente sicuro; grazie al suo sistema di codifica rolling code, assicura la gestione dei comandi in totale sicurezza, impedendo qualsiasi tipo di clonazione o violazione esterna. Come tutti i prodotti della linea ONDA, è possibile installare questa innovativa tastiera in scatole da incasso 503.

Applicazioni: sistemi d'allarme, automazione cancelli, attivazione/disattivazione lampade, serrande, domotica e altre applicazioni.

ONDA DIGITAL W is a wireless keypad studied to be used with different kinds of alarm systems. It can be installed in places of the house or the building where wiring is not possible. This device combines elegance and a robust wave-shaped housing made of satinized grey metal making it a functional back-lit keypad. ONDA DIGITAL W is an extremely reliable product: thanks to its rolling-code encoding system, it enables the user to have a total management of the controls, preventing any cloning and tampering attempts. Like the other ONDA range products, this innovative keypad is compatible with the 503 box.

Applications: alarm systems, gates automation, on/off switching of lighting devices, rolling shutters, domotics and much more.

### RICEVITORE WIRELESS RX ONDA RX ONDA WIRELESS RECEIVER



### Compatibile con BOX 503 BOX 503 compatible

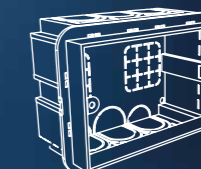

### ONDA DIGITAL W

Tastiera via radio retroilluminata – rolling code – 2 canali – frequenza 433.92 MHz – modulazione ASK. Funziona in abbinamento con ricevitore RX ONDA. Peso: 256 gr.

Wireless backlit keypad – rolling code – 2 channels – 433.92 MHz frequency - ASK modulation. It works combined with RX ONDA receiver. Weight: 256 gr.

### RX ONDA

Ricevitore wireless per ONDA DIGITAL W a 12 Vdc per tastiera via radio. Peso: 24 gr.

Wireless 12 Vdc receiver for keypad ONDA DIGITAL W. Weight: 24 gr.

## RADIOCOMANDI E RICEVITORI VELA

### VELA REMOTE CONTROL AND RECEIVERS

VELA è il radiocomando rolling code a 4 canali con frequenza 433,92 MHz adatto ad un'ampia gamma di funzioni quali il comando a distanza di sistemi antifurto, sirene, accensione luci, attivazione cancelli e basculanti.

VELA is rolling code remote control featuring 4 channels and 433.92 MHz frequency. Vela is a compact, ergonomic and versatile device designed for a number of functions such as remote control in combination with intrusion detection systems, sounders, lights, gates, up-and-over doors.

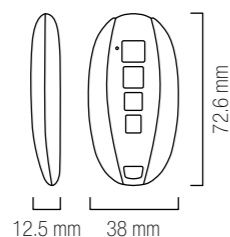

COLORI  
COLOURS



## RICEVITORE 4 CANALI MONO-DIREZIONALE ONE-WAY 4-CHANNEL RECEIVER



**Ricevitore wireless**  
Wireless receiver

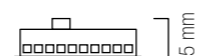

## INFORMAZIONI TECNICHE TECHNICAL INFORMATION

### VELA

Frequenza di funzionamento / Working frequency	433.92 MHz
Tasti / Push-buttons	4
Alimentazione / Power supply	Batteria al Litio 3V (CR2032) 3V Lithium battery (CR2032)
Consumo in trasmissione / Consumption when transmitting	8 mA
Numero canali / Number of channels	4
Tipo oscillatore / Oscillator type	SAW
Temperatura di funzionamento / Working temperature	-10°C ÷ +55°C
Segnalazione batteria scarica / Low-battery signal	SI / YES
Peso / Weight	32 gr.

### VELA RX

Tensione di alimentazione (Vdc) / Power supply (Vdc)	12 Vdc - 30 Vdc
Corrente assorbita (solo ricezione) / Consumption (only receiver)	14 mA
Corrente assorbita (4 uscite attive) / Consumption (4 active outputs)	80 mA
Frequenza di centro banda / Center band frequency	433.92 MHz
Sensibilità / Sensibility	-105 dBm
Banda passante RF - 3 dB / RF Band - 3 dB	± 100 KHz
Numero radiocomandi memorizzabili / Number of remote controls the device can save	1 - 50
Tempo di accensione / Power-up time	2.8 s
Tempo di attuazione comando / Command activation time	0.5 s
Modulazione / Modulation	ASK
Uscita relè impostabile NA o NC / Relays output programmable NO or NC	Si / Yes
Codifica comandi / Command encoding	Rolling Code
Numero canali uscite indipendenti / Number of independent channels and outputs	4
Impostazione uscite / Outputs settings	Monostabile / Monostable Bistabile / Bistable Temporizzata / Temporized
Temperatura di funzionamento / Working temperature	-20°C ÷ +70°C
Peso / Weight	25 gr.



# VELA RX MINI E VELA TX MINI

Comando di un motore (es. tende, tapparelle, elettroserrature)  
Motor control (ex. curtains, rolling shutters, electronic locks)

Accessori per l'illuminazione  
Lighting accessories

VELA RX MINI

VELA RX MINI

Accessori per l'illuminazione  
Lighting accessories

VELA TX MINI

VELA RX MINI

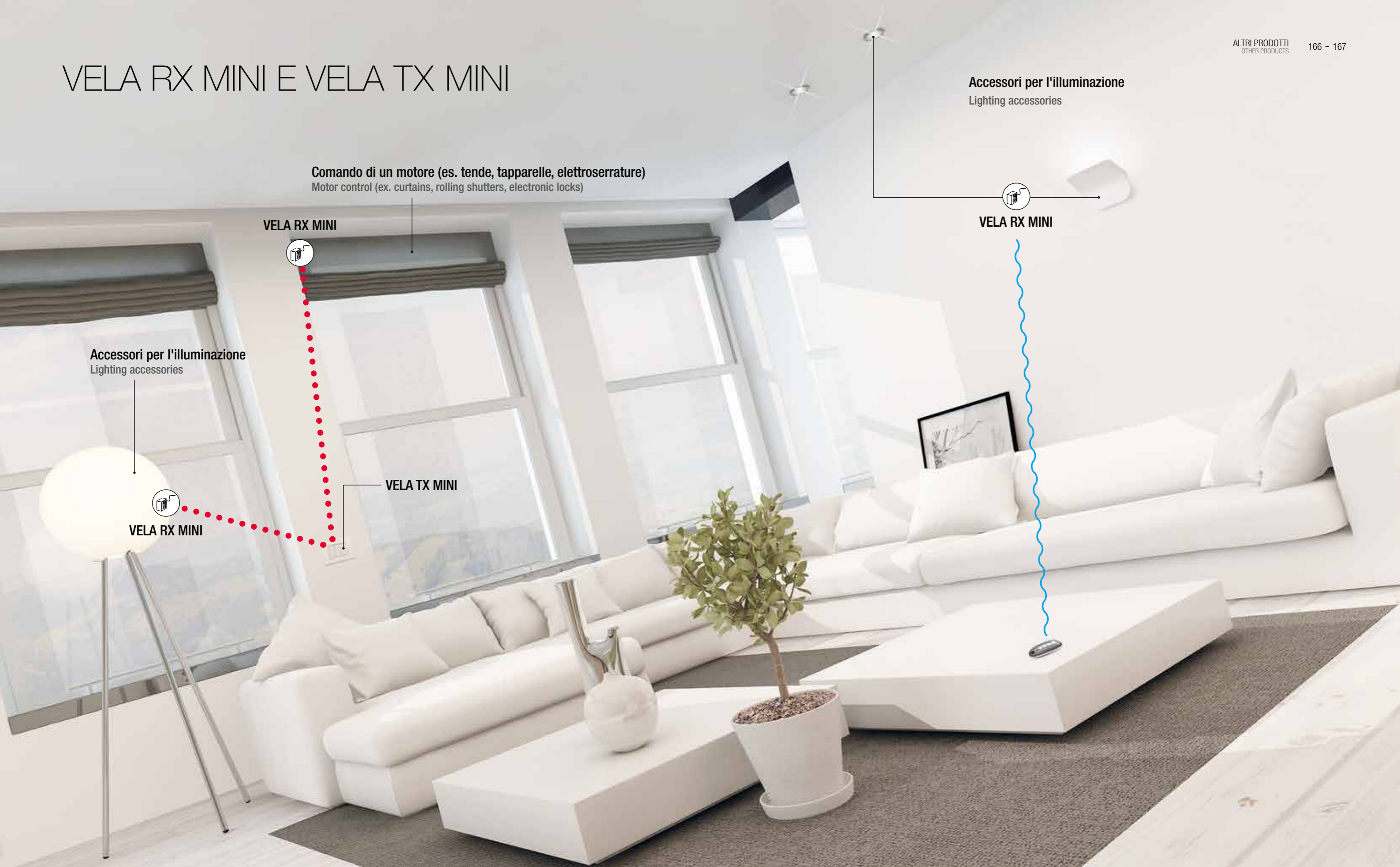

## VELA RX MINI

VELA RX MINI è la ricevente a 230 Vac studiata per l'automatizzazione e l'ampliamento di impianti già esistenti. È comandabile direttamente da radiocomando VELA e può essere inserita, grazie alle dimensioni ridotte, all'interno della scatola 503 o applicata direttamente al dispositivo da automatizzare. Un prodotto semplicissimo da installare, ideale per il restyling di impianti già esistenti, per ridisporre impianti in ambienti già ristrutturati e per le automazioni della casa. VELA RX MINI permette di rinnovare senza passare alcun tipo di cavo, non necessita di trasformatore e possiede un ricevitore radio integrato. Possiede 2 ingressi per 2 pulsanti e 2 relè da 5 Ah MAX programmabili come monostabile, bistabile o temporizzati e permette di comandare tutto quanto possa essere gestito a 230 Vac.

230 Vac VELA RX MINI receiver has been studied for the automation and enlargement of already existing installations. VELA RX MINI can be managed directly through VELA remote control, and, thanks to its small size, this mini board can be integrated in a 503 BOX or applied directly to the product you want to automate.

VELA RX MINI is an extremely easy product to install: the perfect solution to give already existing systems a new style, to reorganize an installation in already modernized environments and in case of in-house automations. VELA RX MINI board enables an installation to be upgraded without pulling out cables or using a transformer. The product comes with an integrated radio receiver, it has 2 inputs for 2 buttons and 2 relays (MAX 5 Ah), and it can be set as mono-stable, bi-stable or adjustable-time relay. Moreover, VELA RX MINI is suitable to control any accessory working at 230 Vac.

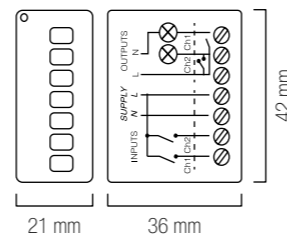

**Compatibile con BOX 503**  
BOX 503 compatible

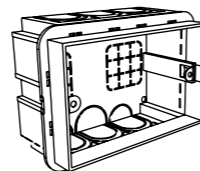

### VELA RX MINI

Tensione di alimentazione / Working voltage	110-250 Vac
Corrente MAX con contatto chiuso / MAX Ah with closed contact	5 A
Portata MAX dei contatti in uscita Vdc / MAX Watt of contacts in Vdc output	5A / 150 W
Consumo in standby / Standby consumption	≤ 0,3W
Frequenza operativa / Working frequency	433.92 MHz
Modulazione / Modulation	OOK / ASK
Tipo oscillatore / Oscillator type	SAW
Portata in area libera / Capacity in open space	150 m
Portata in interni / Capacity in indoor spaces	20 m
Grado di protezione / Protection level	IP 20
Temperatura di funzionamento / Working temperature range	-20°C ÷ +50°C
Dimensioni / Dimensions	21x36x42 mm

**Conforme allo standard Europeo I-ETS 300 220 e ETS 300 683**  
Compliant with ETSI 300 220 e ETSI 300 683 European Standard

## VELA TX MINI

VELA TX MINI è un trasmettitore radio sviluppato per essere montato ad incasso nelle comuni scatole elettriche, ideale per comandare automazioni e punti luce non raggiungibili via cavo. Massima versatilità e sicurezza grazie all'alimentazione a batteria. Il dispositivo è dotato di 2 canali con i quali è possibile gestire 2 punti luce oppure una automazione elettrica con 2 direzioni di funzionamento.

Un dispositivo rolling code che trasmette un codice unico ad ogni pressione dei tasti. La soluzione ideale per applicazioni dove è richiesto un elevato grado di sicurezza.

VELA TX MINI is a radio transmitter module designed to be installed inside the common electrical boxes, ideal for automation and loads control, lights etc. without the need of further cabling. Versatility and safety is achieved thanks to battery power. The device features 2 channels with which it is possible to manage 2 light spots or an electrical automation using 2 operation directions.

VELA TX MINI is a rolling-code device transmitting a unique code for each keystroke. The ideal solution for applications requiring a high security level.

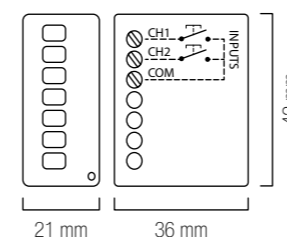

**Compatibile con BOX 503**  
BOX 503 compatible

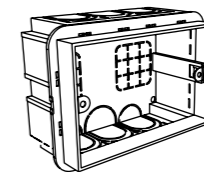

### VELA TX MINI

Alimentazione / Power supply	Batteria al Litio 3V (CR2032) 3V Lithium battery (CR2032)
Assorbimento / Consumption	15 mA
Frequenza operativa / Working frequency	433.92 MHz
Precisione in frequenza / Frequency accuracy	± 100
Potenza di uscita / Output power	+5 dBm
Portata in interni / Capacity in indoor spaces	30 m
Grado di protezione / Protection level	IP 20
Temperatura di funzionamento / Working temperature range	-10°C ÷ +50°C
Dimensioni / Dimensions	21x36x42 mm

# LA NOSTRA STRUTTURA

OUR STRUCTURE



# LA NOSTRA STRUTTURA

## OUR STRUCTURE

Venitem è un'azienda in continua espansione, certificata ISO 9001 e 14001, strutturata in modo da favorire un perfetto funzionamento del sistema produttivo e un puntuale servizio al cliente. L'azienda vanta tre sedi di proprietà ed uno spazio produttivo che raggiunge i 3500 mq nella sola sede di Salzano (Venezia). Gli ampi uffici risultano ben organizzati e studiati per rispondere al meglio alle esigenze del personale.

Il comparto di ricerca e sviluppo è dotato di sofisticate apparecchiature per la progettazione e l'area produttiva è organizzata in modo da rendere rapida ed efficiente ogni fase di lavorazione, che avviene interamente in azienda, con un metodo quasi artigianale per minuziosità ed attenzione per il dettaglio.

Expansion is steady at Venitem. The Company is ISO 9001 and 14001 certified, and its structure has been developed to make the production system work perfectly to the aim of granting our customers a top-level supply service. Venitem boasts a great production area of 3,500 sq m located in the headquarter based in Salzano (Venice) and two other offices. The roomy spaces are well organized and conceived to provide Venitem's staff with a comfortable environment to work in.

The R&D department is equipped with cutting-edge technical tools and devices and the manufacturing area is planned to make every manufacturing stage fast and well organized. The production at Venitem starts and ends inside the Company's headquarter using an accurate manufacturing system: attention is paid to every single detail to offer products seeming almost handmade.

## IL MERCATO

### THE MARKET

Distinguersi per la qualità e l'efficienza, rinnovando gli schemi del design con una gamma di prodotti in continua evoluzione. Venitem da sempre studia le esigenze del mercato e vi risponde con soluzioni "smart", affidabili e innovative.

Venitem wants to stand out for the quality and efficiency of its products, by renewing the rules of design with an ever-developing product range. Venitem is always studying the market demand, to reply with smart, reliable and innovative solutions.

## IL CLIENTE

### THE CUSTOMER

Una particolare attenzione alle richieste della clientela e lo studio di soluzioni personalizzate fanno di Venitem un solido punto di riferimento nel mercato oltre che un partner ideale per la soddisfazione di qualsiasi tipo di necessità.

Great attention to customer's requirements together with the analysis of personalised solutions make Venitem a solid point of reference on the market, as well as the perfect commercial partner able to satisfy any needs.

## LE PERSONE

### PEOPLE

Il Team Venitem è composto da personale preparato e altamente specializzato capace di offrire alla propria clientela un servizio di vendita e post vendita completo, puntuale e professionale.

Venitem team includes an skilled and highly-specialised staff, able to provide the customer with a comprehensive, accurate and professional sales and after-sales service.

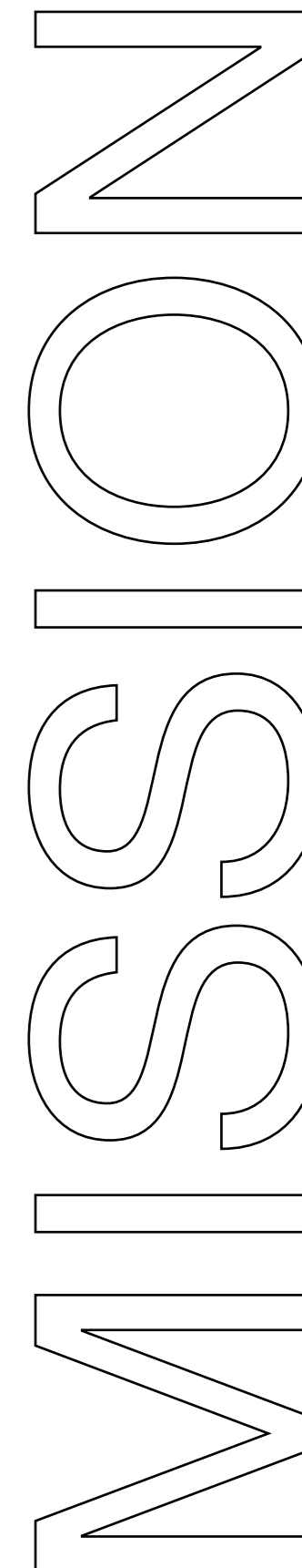

ELENCO MODELLI DEPOSITATI

REGISTERED MODELS

MOSE - MURANO - DOGE / DUCALE - HOLA - RIO - RONDÒ - MINI DOGE - MINI MURANO - MINI HOLA

BREVETTI

PATENTS

SISTEMA ANTISCHIUMA - ANTISHOCK / ANTI-FOAM AND ANTI-SHOCK SYSTEM (N. 00238576)

MOSE LIGHT: SISTEMA INDIPENDENTE DI ILLUMINAZIONE A LED / INDEPENDENT LED LIGHTING SYSTEM



06.2016





Via del Lavoro, 10  
30030 Salzano (Venezia) – ITALY  
T. +39 041 5740374 – F. +39 041 5740388  
info@venitem.com – www.venitem.com